

DUOX^{plus}
by FERMAX

More powerful

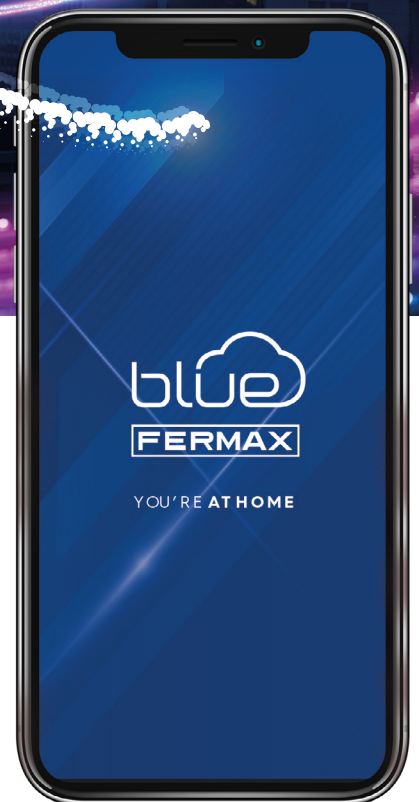

THE ONLY **FULLY DIGITAL**
DOOR ENTRY SYSTEM **IN 2 WIRES**



DUOX^{plus}

More powerful

FERMAX



The new advanced DUOX system offers much more

Higher performance and increased capacity, faster and more user-friendly, but above all, it brings us to a new technological dimension destined to define the future of video door systems.

DUOX PLUS brings the **MOST POWERFUL**
2-wire digital system to your home.

2 wires

A fully digital door entry system that works with 2 non-polarised wires from start to finish in the installation.

scalable

Up to 10 panels and 10 guard units at the general entrances.

Up to 10 panels and 10 guard units in each building or block of apartments.

Up to 100 blocks and sub-blocks.

user-friendly

Since the system is entirely digital, the type of wiring has much less of an effect on the quality and performance of the system.

Furthermore, very few intermediary elements are required, which saves considerable time in the installation.

intuitive

The DUOX PLUS monitors can be programmed in just a few seconds, directly from the OSD menu.

no limits

DUOX is designed to work with all kinds of projects; large or small, simple or complex, vertical structures or horizontal installations.

product range

A broad variety of outdoor panels and indoor terminals with an exclusive design and advanced functions, without any increase in price.

connectivity for everyone

With DUOX PLUS, Fermax can introduce any kind of building or home to the world of connectivity, incorporating mobile call divert into even the most basic monitors.

+ capacity

DUOX PLUS allows you to push the boundaries of digital technology. Thanks to the digitalisation of the system, it can now be used in all kinds of installations.

The more complex the installation is, the more powerful DUOX PLUS will be.



+ flexibility

Can be easily replaced, with no need to change the installed wiring. Considerable time saving during installation and maintenance.



+ technology

- . Designed to handle external interference.
- . Consistent quality throughout the installation.
- . The regenerators boost the signal.
- . Capable of communicating over long distances.

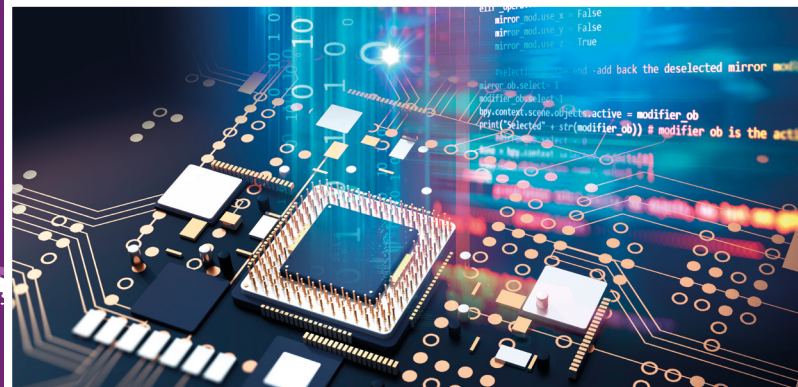

+ functions

DUOX PLUS is a system designed for everyone. Not just for its intuitive and attractive design, but also because it provides more advantages and functions for both the installer and the end user, at no additional cost.





connectivity

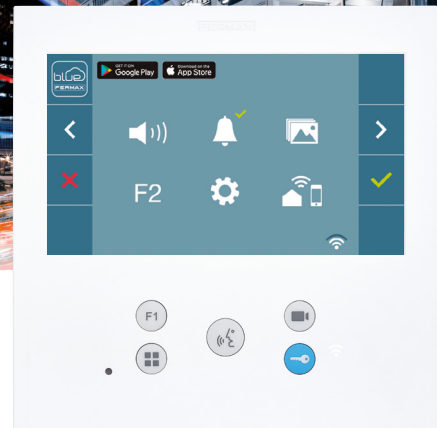
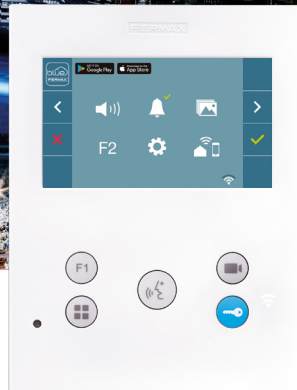
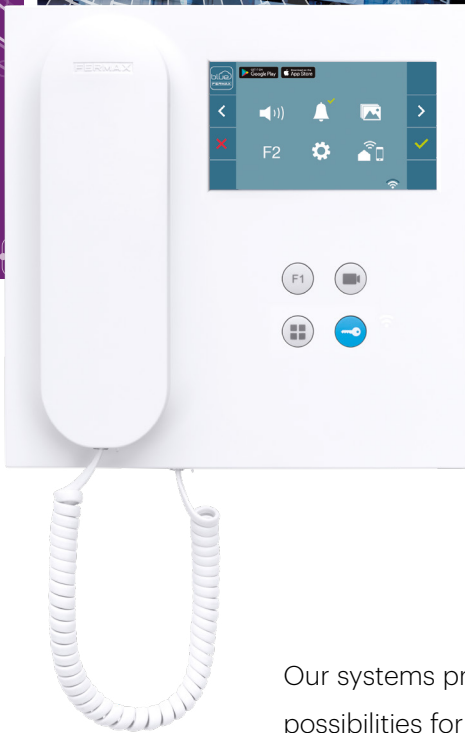

Our systems provide a wide range of different possibilities for security, mobility and comfort, inside and outside the home.

All video kits now include a WiFi monitor as standard, at no extra cost!



DUOXplus

CONNECTIVITY FOR ALL



DUOX plus

FERMAX



product range

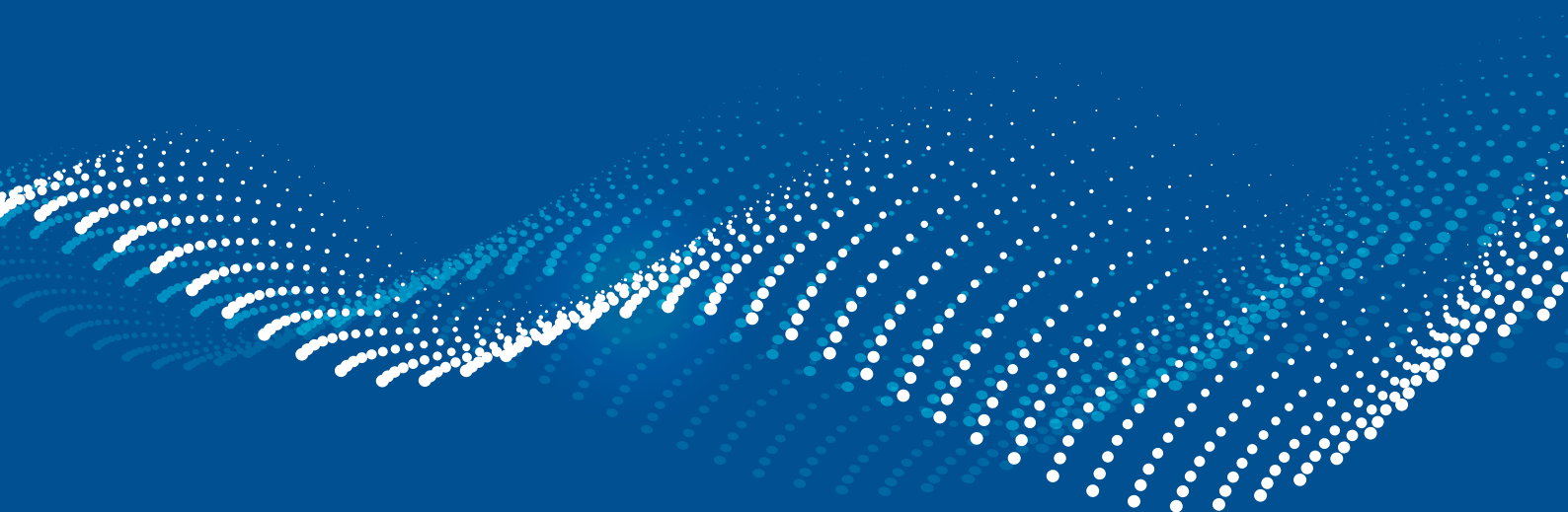



WiFi monitors

Features of WiFi monitors

VEO and VEO-XS 4.3" colour monitors and VEO-XL 7" colour monitors, made from high-impact ABS plastic and UV protection, with settings for contrast, brightness, colour, audio volume, call ring tone volume, do not disturb function, doorbell, date and time, silicone buttons for activating the lock release that are pleasant to the touch, access to the main OSD menu from the screen, activation of the outdoor panel camera, and various other additional configurable functions such as activating second access, courtesy light, etc. Available in white and for surface installation.

Three WiFi monitor options: the VEO monitor with its unique handset design incorporating a magnet that enables the user to hang up correctly at the end of the conversation, and the VEO-XS and VEO-XL hands-free monitors.



Photocaller



Automatically captures an image of the person who calls. If the user decides to activate this function, the monitor will save up to 150 images, with the date and time when they were taken. Once maximum capacity has been reached, taking a new photo will delete the first one that was saved. The screen will always tell you if there are photos that you haven't seen or if the date/time has not been configured.

Call divert to mobile

The DUOX PLUS VEO, VEO-XS and VEO-XL WiFi monitors are equipped with a WiFi connection, allowing for calls to be diverted to mobile devices.

With the BLUE app by FERMAX you can manage all the video door functions and much more directly from your mobile phone or tablet.





Free App





VEO, VEO-XS AND VEO-XL WiFi MONITORS

- 9446** DUOX PLUS VEO WiFi MONITOR
-  **9456** DUOX PLUS VEO WiFi MONITOR WITH INDUCTIVE LOOP
Dimensions: 200x200x23 mm (44 mm with handset).
- 9449** DUOX PLUS VEO-XS WiFi MONITOR
-  **9459** DUOX PLUS VEO-XS WiFi MONITOR WITH INDUCTIVE LOOP
Hands-free. Dimensions: 125x165x21mm.
- 9469** DUOX PLUS VEO-XL WiFi MONITOR
-  **9479** DUOX PLUS VEO-XL WiFi MONITOR WITH INDUCTIVE LOOP
Hands-free. Dimensions: 185x185x21mm.
- 9447** DUOX PLUS CONNECTOR
Mounting support for VEO, VEO-XS and VEO-XL monitors.



<< If you'd like to watch our video to find out more, scan this code



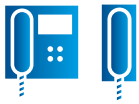

monitors and telephones

VEO, VEO-XS AND VEO-XL MONITORS

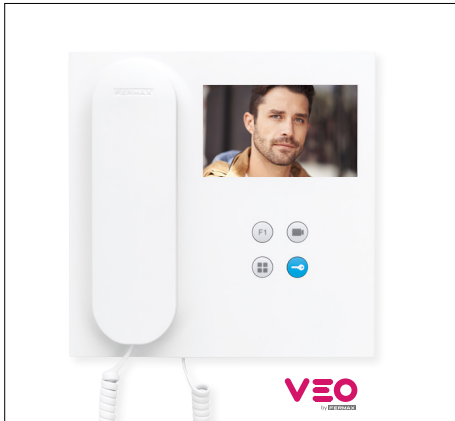

9445 DUOX PLUS VEO MONITOR

 **9455** DUOX PLUS VEO MONITOR WITH INDUCTIVE LOOP

Dimensions: 200x200x23 mm (44 mm with handset).

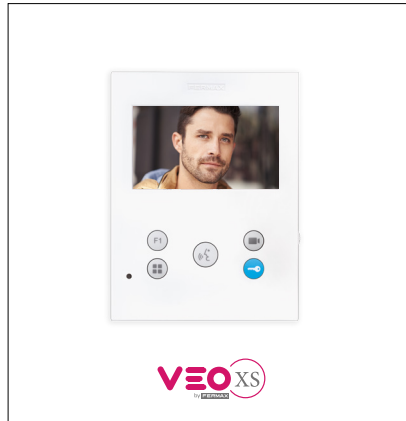

9448 DUOX PLUS VEO-XS MONITOR

 **9458** DUOX PLUS VEO-XS MONITOR WITH INDUCTIVE LOOP

Hands-free. Dimensions: 125x165x21 mm.

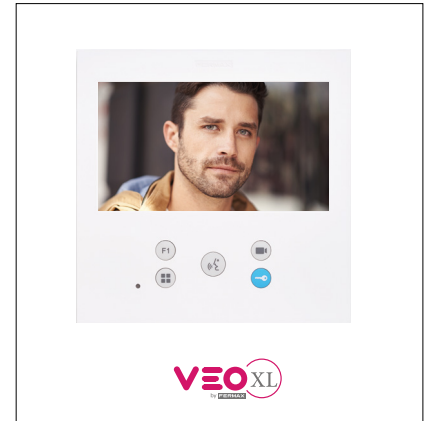

9468 DUOX PLUS VEO-XL MONITOR

 **9478** DUOX PLUS VEO-XL MONITOR WITH INDUCTIVE LOOP

Hands-free. Dimensions: 185x185x21 mm.

9447 DUOX PLUS CONNECTOR Mounting support for VEO, VEO-XS and VEO-XL monitors.

VEO, LOFT AND iLOFT TELEPHONES



3444 DUOX PLUS VEO TELEPHONE

Includes volume control.
Dimensions: 82x214x43 mm.



3452 DUOX PLUS LOFT EXTRA TELEPHONE

Includes 2 buttons for extra functions: turn on lights, open 2nd door, etc.
Dimensions: 85x220x40 mm.



3450 iLOFT DUOX PLUS TELEPHONE

Hands-free. Includes volume control and a button for additional function.
Dimensions: 90x146.5x20 mm.



AUDIO GUARD UNIT

9423 DUOX PLUS AUDIO VEO GUARD UNIT

DUOX PLUS Audio Guard Unit has a multi-functional 4,3" capacitive touchscreen and quick function access buttons for easy convenient management. Its unique handset design incorporating a magnet enables the user to put it back into position correctly. It includes a stainless steel desktop support. It allows a surface installation.

Dimensions: 200x200 mm. Support included.

Dimensions: (width) x (height) x (depth) mm.



SKYLINE

FERMAX MODULAR PANEL

Made of aluminium, it is the most versatile panel. Its modularity allows to respond to any residential or commercial project.

CITYLINE DIGITAL

MONOBLOCK CONCEPT PANEL

Characterised by its curved profile, it is manufactured in a highly weather resistant anodised aluminium profile.

MARINE

VANDAL-PROOF DOOR ENTRY PANEL

Made in stainless steel. It is the perfect choice for adverse or extreme climate conditions.

MARINE ELITE

A VERY OWN PRODUCT

The MARINE ELITE range of panels allows total creative freedom: any colour, any size and any composition.



outdoor panels



SKYLINE Modular design. Anodised aluminium. IP43 IK07

FRAMES

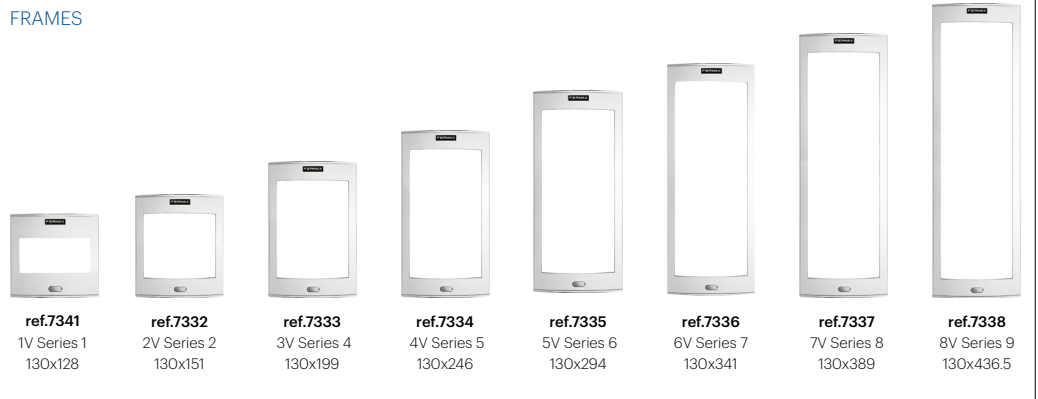

VIDEO



ref.73911
Video W

AUDIO



ref.73902
Audio W

DOUBLE PUSH BUTTONS



ref.7371
8 PUSH.
2x4 W

ref.7372
4 PUSH.
2x2 V

ref.7376
2 PUSH.
2x1 V

SIMPLE PUSH BUTTONS



ref.7367
4 PUSH.
1x4 W

ref.7368
2 PUSH.
1x2 V

ref.7375
1 PUSH.
1x1 V

INFORMATIVE MODULES



ref.7445
Panoramic
cardholder W



ref.7444
Panoramic
cardholder V

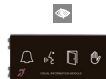

ref.7448
OneToOne V



ref.7452
OneToOne V
w/inductive loop

ACCESS CONTROL



ref.7438
Memokey
keypad W



ref.6936
Fingerprint
reader W



ref.7463 ref.7440
Proximity
reader V

DIGITAL MODULES



ref.7439
Direct keypad W



ref.7470
Graphic display W



ref.7457
Digital keypad W

ACCESSORIES



ref.7443
Metallic complement W



ref.7442
Metallic complement V

ACCESSORIES	S1 (1V)	S2 (2V)	S4 (3V)	S5 (4V)	S6 (5V)	S7 (6V)	S8 (7V)	S9 (8V)
flush box	ref.8851 115x114x45	ref.8852 115x138x45	ref.8854 115x185x45	ref.8855 115x233x45	ref.8856 115x280x45	ref.8857 115x328x45	ref.8858 115x375x45	ref.8982 115x420.5x45
surface box	ref.7061 130x128x33	ref.7062 130x151x33	ref.7064 130x199x33	ref.7065 130x246x33	ref.7066 130x294x33	ref.7067 130x341x33	ref.7068 130x389x33	ref.7069 130x436.5x33
simple hood	ref.8400 135x130	ref.8401 135x155	ref.8403 135x203	ref.8404 135x250	ref.8405 135x300	ref.8406 135x345	ref.8407 135x393	ref.8480 135x440.5
modular decorative frame*	ref.9191 211x210	ref.9192 211x234	ref.9194 211x281	ref.9195 211x329	ref.9196 211x376	ref.9197 211x424	ref.9198 211x471	ref.9199 211x519
simple city decorative frame	ref.8251 225x310	ref.8252 225x310	ref.8254 225x375	ref.8255 225x375	ref.8256 225x450	ref.8257 225x450	ref.8258 225x450	ref.8259 225x495
angular complement	ref.8378	ref.8379	ref.8381	ref.8382	ref.8383	ref.8384	ref.8385	ref.8386

If the configuration requires more than one panel, they will need to be connected together with a connection cable (ref. 2541) (1 cable for each additional panel) and a set of joining bolts (ref. 8829) to attach them to unite the flush boxes.

* To make DOUBLE modular frames, add to the SINGLE frame a DOUBLE PANEL MODULAR FRAME KIT (ref. 9200). Horizontal: 341 mm.

* To make TRIPLE modular frames, add to the SINGLE frame a TRIPLE PANEL MODULAR FRAME KIT (ref. 9201). Horizontal: 471 mm.

CITYLINE Monoblock design panel. Anodised aluminium. IP43 IK07

DIRECT CITYLINE PANEL

The DIRECT panels have a keypad to call the apartments. The keypad admits 1 code to open the door.



73631 DUOX PLUS DIRECT VIDEO CITY PANEL S5

73638 DUOX PLUS DIRECT VIDEO CITY PANEL S5

In addition to being able to call the main guard unit by pressing the "bell key" button, this outdoor panel model also includes a button to call directly at the General Entrance from a block panel. The address of the guard unit that is called with this button must be previously configured by the installer.

8855 FLUSH BOX S5

8829 JOINING BOLTS SET

NOTE. Recommended to add DIRECTORY SKYLINE PANEL S5 (ref.7334 and 2 units ref.7445).



DIGITAL CITYLINE PANEL

The DIGITAL panels include a KEYPAD and a 3,5" EXTRA display. The keypad integrates access control function (10.000 codes).

73871 DUOX PLUS DIGITAL VIDEO CITY PANEL S7

73811 DUOX PLUS DIGITAL VIDEO CITY PANEL PROX S8

73878 DUOX PLUS DIGITAL VIDEO 1W CITY PANEL S7

73818 DUOX PLUS DIGITAL VIDEO 1W CITY PANEL PROX S8

In addition to being able to call the main guard unit by pressing the "bell key" button, this outdoor panel model also includes a button to call directly at the General Entrance from a block panel.

8857 FLUSH BOX S7

8858 FLUSH BOX S8

8829 JOINING BOLTS SET

NOTE. Recommended to add according to the size of the panel:

- DIRECTORY SKYLINE PANEL S7 (ref.7336 and 3 units ref.7445).
- DIRECTORY SKYLINE PANEL S8 (ref.7337, ref.7444 and 3 units ref.7445).



outdoor panels



MARINE Stainless steel vandal-proof panel. 316L. IP65 IK09

SERIE ST1 Panel: 150x180

Flush box. (ref.4641): 130x160x55



ref.44438
1 Push.
150x180

ref.44338
1 Push.
150x180

ref.44348
2 Push.
150x180

SERIE ST2 Panel: 150x240

Flush box. (ref.4642): 130x220x55



ref.44358
2 Push.
150x240

ref.44368
3 Push.
150x240

ref.44378
4 Push.
150x240

The MARINE outdoor panels with push buttons (except 1 and 2 ways VIDEO panels), always require a call extension module, depending on the number of push buttons. (ref. 2008 - 8 call extension module, ref. 2441 - 16 call extension module).

- 55261** DUOX PLUS DIGITAL MARINE VIDEO PANEL ST3
- 55281** DUOX PLUS DIGITAL MARINE VIDEO PANEL W/PROX ST4

- 55268** DUOX PLUS DIG 1/W MARINE VID PANEL ST3+
 - 55288** DUOX PLUS DIG 1/W MARINE VID PANEL PROX ST4
- With a push button to call any concierge
DUOX PLUS ref. 9423.

In addition to being able to call the main guard unit by pressing the "bell key" button, this outdoor panel model also includes a button to call directly at the General Entrance from a block panel.

- 5471** DIRECTORY PANEL ST3
Dimensions: 150x360mm



ref.55261

ref.5471

ref.55268

ref.55281

ref.55288

ACCESSORIES	FLUSH BOX	SURFACE BOX (with hood)	SIMPLE HOOD (for flush box)
ST1	ref.4641 130x160x55	ref.4645 154x184x96	ref.4701
ST2	ref.4642 130x220x55	ref.4646 154x244x96	ref.4702
ST3	ref.4643 130x340x55	ref.4647 154x364x96	ref.4703
ST3+	ref.4653 130x400x55	ref.4654 154x423x96	ref.4655
ST4	ref.4644 130x465x55	ref.4648 154x489x96	ref.4704

If the configuration requires more than one panel, they will need to be connected together with a connection cable (ref. 2541) (1 cable for each additional panel) and a set of joining bolts (ref. 2289) to attach them to unite the flush boxes.

Dimensions: (width) x (height) x (depth) mm.

MARINE ELITE



FERMAX has a laser-cut machining line for stainless steel panels. This process allows us to offer complete flexibility when it comes to producing the required Marine panel, with optimal delivery time for personalisation.



RAL 9005

GOLD COLOUR

BRASS COLOUR

31728 DUOX PLUS MARINE ELITE PANEL

The following variations may be ordered:

- Panel with special formats and dimensions.
- Integration of access control modules and special combinations.
- Logotype laser marking. The engraving of panels is only available on the panels with stainless steel colour. Other colours cannot be engraved.
- Residence/Building number and messages integration.
- Push buttons without card slot and free layout.
- Backlight option.

4579 MARINE ELITE RAINHOOD FOR FLUSH BOX PANEL

4580 MARINE ELITE FLUSH BOX

4581 MARINE ELITE SURFACE BOX (WITH HOOD)

Surface boxes and hoods are not available in brass colour.

The MARINE Elite panels are available in several colours, indicate the desired RAL when ordering your panel.



RAL 3020

RAL 5005

GOLD

RAL 9018

RAL 9016



Check for availability in other colours.

You can find the application for special panels and frames on our website:
<https://fermax.com/intl-en/tools/special-panels>



accessories

DECODER

9419 DECODER/AISLADOR DUOX PLUS

10-outputs floor decoder. One output per home, allowing up to 3 terminals (monitors/telephones) per home. Each output allows to increase the diversion distances on a floor up to 100 m.



In the event of a malfunction (short circuit) of any of the decoder's outputs the rest of the outputs will continue to operate normally.

It is not necessary to enter a house to program the address of the terminal since the decoder includes a group of microswitches (dipswitches) to program the addresses of each of its outputs (sequential programming). Also, the decoder addresses can be programmed non-sequentially (open programming).

The decoder is powered directly from the DUOX PLUS bus. With DIN10 rail mounting and removable terminal strips for easy wiring and installation.

POWER SUPPLY AND ADAPTORS



3255 DUOX PLUS LINE ADAPTOR
Necessary at the beginning and the end of every riser.

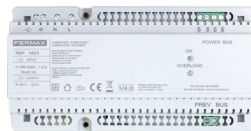

4825 POWER SUPPLY + FILTER
24Vdc-2.5A DIN10



4840 POWER SUPPLY DIN-6
100-240Vac/24Vdc-2A

To be used exclusively with the filter ref. 3289 or with the 2 WAY Regenerator ref. 3269.

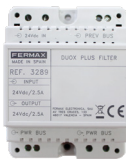

3289 FILTER DUOX PLUS 24Vdc

To be used with the PSU ref. 4840, in those installations where the PSU ref. 4825 cannot be used due to its dimensions. Cannot be used with 18Vdc power supplies, which must be installed with filter ref. 3244.



4802 POWER SUPPLY 12Vac/1A DIN4

4800 POWER SUPPLY 12Vac/1,5A DIN4

For altern lock release.

TERMINAL CONSUMPTION TABLE PER POWER SUPPLY **IN DISTRIBUTION (4 X FLOOR)**

	VEO MONITOR		VEO-XS MONITOR		VEO-XL MONITOR	
	NO WIFI	WIFI	NO WIFI	WIFI	NO WIFI	WIFI
1.0mm ²	40	28	40	28	34	24
0.5mm ²	40	24	40	24	30	22
0.2mm ²	32	18	26	18	20	12

TERMINAL CONSUMPTION TABLE PER POWER SUPPLY **IN CASCADE**

	VEO MONITOR		VEO-XS MONITOR		VEO-XL MONITOR	
	NO WIFI	WIFI	NO WIFI	WIFI	NO WIFI	WIFI
1.0mm ²	40	26	40	22	30	20
0.5mm ²	32	20	28	18	22	14
0.2mm ²	16	12	14	10	10	8

REGENERATORS

They allow the signal to be regenerated and amplified in both ways, and they also increase distances and the number of terminals. The sections connected to the input and output protect against short-circuit, overloads and signal reflections. Maximum of 5 units in cascade. Up to 99 if they are connected in parallel.

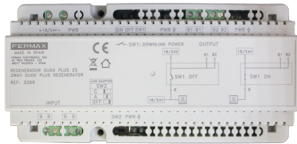

3269 2/W DUOX PLUS REGENERATOR

It has 1 input and 2 outputs. By having 2 outputs (also isolated from each other) it enables the number of risers to be increased. Requires 24Vdc power supply without filter (ref. 4840).

For more information: <https://fermax.com/intl-en/documents>



3268 1/W DUOX PLUS DUAL REGENERATOR

It has 1 input and 1 output. As per factory default settings, electrical energy does not flow, but this can be configured via a dipswitch so that the data (which regenerates) as well as the power supply can pass through. That way there is no need to always install a power supply at the output. The number of devices that can be fed at the output without an additional power supply units will depend on the power that reaches the regenerator.

For more information: <https://fermax.com/intl-en/documents>

	No. of inputs	No. of outputs	Regenerates	Isolates	Incorporates power supply filter	Additional conversation channel per riser
3269	1	2	YES	YES	YES	NO
3268	1	1	YES	YES	NO	YES (in multichannel mode)

ACCESSORIES



3233 DUOX PLUS BASIC RELAY

Basic functions. Allows you to activate an additional function from F1 or F2 of the DUOX PLUS terminals, without additional wiring. The relay can also be activated by the call or by activating the lock release. It can be connected at any point of the bus.



3267 DUOX PLUS RELAY MODULE

Advanced functions. Allows you to pair 2 relays, 1 as a transmitter and other as a receiver, to perform remote activations. An address can be programmed with the address assistance (001-999) using the DUOX PLUS Programmer ref. 3254 via the relay's telephone connector.



67501
UNIVERSAL LOCK RELEASE 990N-P22 MAX 10-24Vac/dc

6750
UNIVERSAL MECHANISM 990N MAX 10-24Vac/dc

6752
UNIVERSAL MECHANISM 990A MAX 12-24Vac/dc



2040 CALL EXTENSION MODULE



2438 LIGHT/DOOR BELL ACTIVATOR

VIDEO DOOR KITS

WIFI
MONITOR
AS STANDARD





94411 1/W DUOX PLUS VEO WiFi KIT
94421 2/W DUOX PLUS VEO WiFi KIT

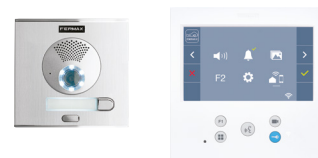

94511 1/W DUOX PLUS VEO-XS WiFi KIT
94521 2/W DUOX PLUS VEO-XS WiFi KIT



9471 1/W DUOX PLUS VEO-XL WiFi KIT
9472 2/W DUOX PLUS VEO-XL WiFi KIT



49081 1/W DUOX PLUS VEO WiFi ONE-TO-ONE KIT



50731 1/W DUOX PLUS VEO-XS WiFi MARINE KIT



50831 1/W DUOX PLUS VEO-XS WiFi MARINE BLACK KIT



50781 1/W DUOX PLUS MARINE ONE-TO-ONE VEO-XS WiFi KIT



49071 1/W DUOX PLUS VEO WiFi MEMOVISION KIT



49121 1/W DUOX PLUS VEO-XS WiFi MEMOVISION KIT

KITS EXTENSIONS

INDOOR: up to 2 terminals without additional power supply (total terminals per home = 3). Depending on the type of cable and distances, additional power supply (ref. 4825), line adaptors ref. 3255 and/or regenerators might be required.

OUTDOOR: It is possible to extend the installation by adding more outdoor panels (up to 10). Depending on the type of cable and topology, additional power supply (ref. 4825), line adaptors ref. 3255 and/or regenerators might be required.

INSTALLATION DIAGRAM

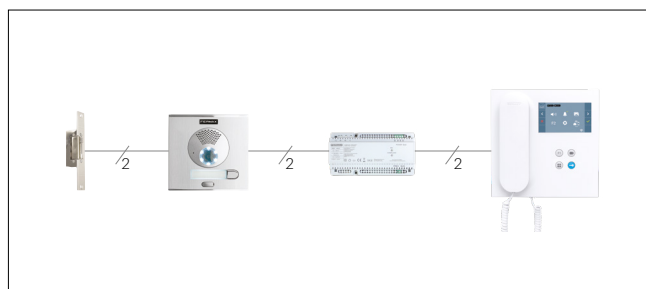

AUDIO KITS



49202 1/W DUOX PLUS AUDIO CITY VEO KIT
49212 2/W DUOX PLUS AUDIO CITY VEO KIT



49132 1/W DUOX PLUS AUDIO MEMOPHONE CITY VEO KIT



50772 1/W DUOX PLUS AUDIO CITY iLOFT KIT



50762 1/W DUOX PLUS AUDIO MARINE iLOFT KIT

KITS EXTENSIONS

INDOOR: up to 2 terminals without additional power supply (total terminals per home = 3). Depending on the type of cable and distances, additional power supply (ref. 4825), line adaptors ref. 3255 and/or regenerators might be required.

OUTDOOR: It is possible to extend the installation by adding more outdoor panels (up to 10). Depending on the type of cable and topology, additional power supply (ref. 4825), line adaptors ref. 3255 and/or regenerators might be required.

INSTALLATION DIAGRAM

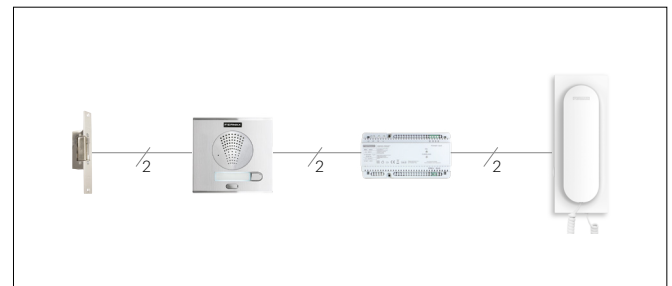

ACCESSORIES

VEO, VEO-XS AND VEO-XL MONITORS

- 3388** UNIVERSAL DECORATIVE FRAME 120X240 (ONLY VEO-XS)
- 3389** UNIVERSAL LARGE DECORATIVE FRAME 210X240
- 9410** VEO MONITOR DESKTOP SUPPORT
- 9420** VEO-XS AND VEO-XL MONITOR DESKTOP SUPPORT

iLOFT TELEPHONE

- 3388** UNIVERSAL DECORATIVE FRAME 120X240
- 3389** UNIVERSAL LARGE DECORATIVE FRAME 210X240
- 5636** iLOFT TELEPHONE DESKTOP SUPPORT

VEO AND LOFT TELEPHONES

- 3380** LOFT TELEPHONE DECORATIVE FRAME 120X240 200X240
- 3388** UNIVERSAL DECORATIVE FRAME 120X240
- 3389** UNIVERSAL LARGE DECORATIVE FRAME 210X240
- 3749** VEO / LOFT TELEPHONE DESKTOP SUPPORT
-  **3441** LOFT HANDSET WITH INDUCTIVE LOOP
-  **3443** VEO HANDSET WITH INDUCTIVE LOOP

CITYLINE AND MARINE PANELS

SEE OUTDOOR PANEL SECTION

DUOX^{plus}

FERMAX

technical information



DIAGRAM. DUOX PLUS VIDEO

1 ACCESS VIDEO DUOX PLUS TO 2 RISERS OF 4 FLOORS. 2 APARTMENTS PER FLOOR

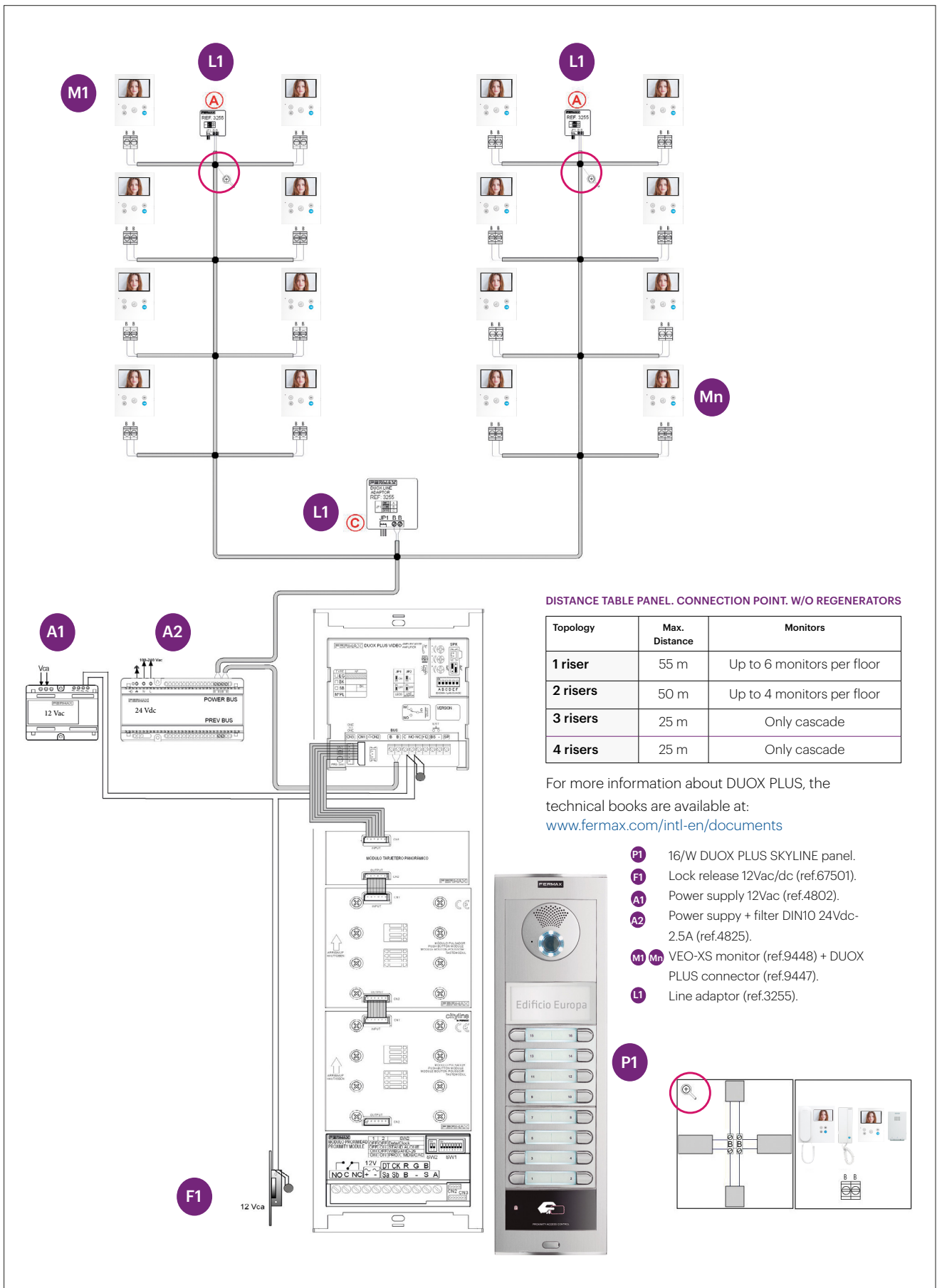

DISTANCE TABLE PANEL. CONNECTION POINT. W/O REGENERATORS

Topology	Max. Distance	Monitors
1 riser	55 m	Up to 6 monitors per floor
2 risers	50 m	Up to 4 monitors per floor
3 risers	25 m	Only cascade
4 risers	25 m	Only cascade

For more information about DUOX PLUS, the technical books are available at:

www.fermax.com/intl-en/documents

- P1** 16/W DUOX PLUS SKYLINE panel.
- F1** Lock release 12Vac/dc (ref.67501).
- A1** Power supply 12Vac (ref.4802).
- A2** Power supply + filter DIN10 24Vdc-2.5A (ref.4825).
- M1 Mn** VEO-XS monitor (ref.9448) + DUOX PLUS connector (ref.9447).
- L1** Line adaptor (ref.3255).

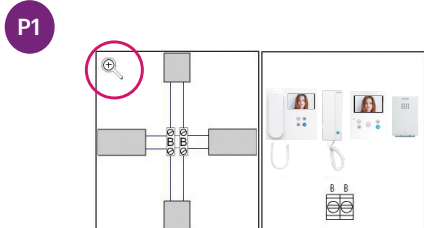
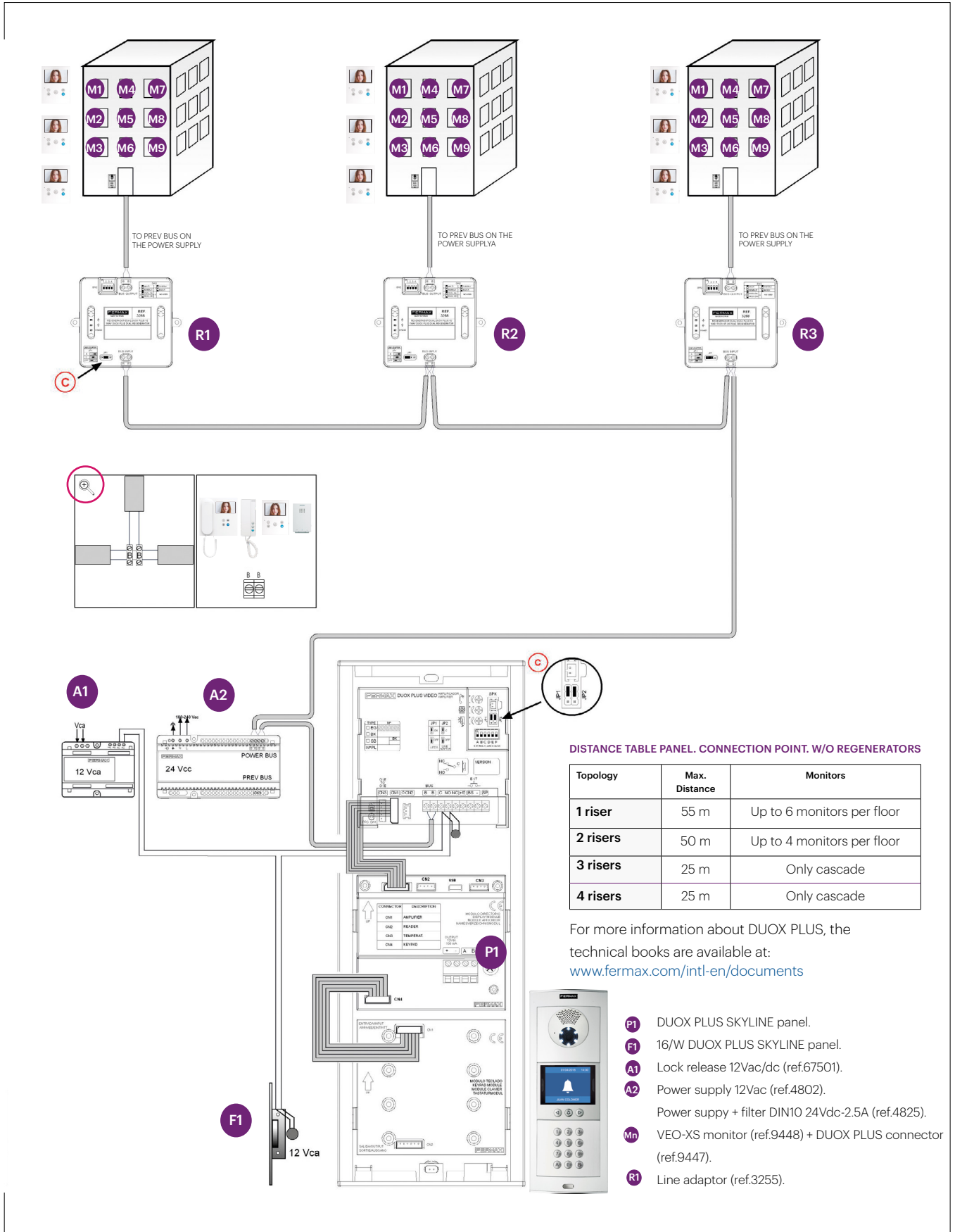

DIAGRAM. **DUOX PLUS VIDEO**

1 ACCESS VIDEO DUOX PLUS TO 3 INTERIOR BLOCKS



FERMAX

CONNECTIVITY FOR ALL

www.fermax.com | fermax@fermax.com

