

EMERGENCY DOWN LIGHT

Data Sheet

For Series: OT-ECL3-M serial



OTC IND CO., LTD

TEL: 0086-575-82913009 | Website: www.otcenterprise.com | Email: info@otcind.net



Dear partners,

* Thanks for choosing OTC emergency devices for your projects.

OTC always pursue high quality, steady quality products, competitive price and one-stop customer service, and offer enjoyable installation experience.

* All the OTC emergency device with 5 years quality guarantee (Battery 3 years) . If any doubts/ questions, please contact OTC project support team directly by email support@otcind.net . You will get solutions in 7~24 hours rapidly.

Contents

1 Security realated information	2
2 Packing list	2
3 Basic Parameters	3
4 Maintained & Non-maintained	4
5 Self-test system	5
6 Emergency controll logic	6
7 Emergency function & Wiring	7
8 Installation guide (Recessed)	8
9 Installation guide (Ceiling mounting)	9
11 EM inspection record table	10

1 Security related information

- Installation should be carried out in accordance with the latest edition of the I.E.E. Wiring regulations and taking into consideration the latest building regulations.
- Ensure that all electrical connections are tight with no loose strands, including factory made connections.
- Ensure there is adequate free air circulation of at least 100mm around the luminaire. It is the installer's responsibility to consider fire risk and take appropriate precautions.
- A separate enclosure may be required if this unit is to be used in dusty and wet environments.

Q.C. date label, installation in an improper working environment or installation not according to the current edition of the I.E.E. Wiring Regulations . The guarantee is also invalidated if the luminaire has been I.R. tested. Should this product fail during the guarantee period it will be replaced free of charge, subject to correct installation and return of the faulty unit. We do not accept responsibility for any installation costs associated with the replacement of this product. Your statutory rights are not affected. We reserve the right to alter specifications without prior notice.

2 Packing list



OT-ECL3-M *1



Spring set *1
For recessed mounting



The ceiling mount decoration trim *1



Installation pack*1



Remote test controller
OT-ECL3-M-RST only
Optional



Usermanual *1

3 Basic Parameters

Model	Art Nr. OT-ECL3-M	
	ST	RST
Material	PC case	
Color Rendering Index	>80	
LED Chip	7 pcs SMD 2835	
Degree of protection	IP42	
Input Voltage	AC200-240V 50/60HZ	
Emergency mode	Maintained & non-maintained in one	
Input Power	5.0W if maintained / 1.5W if non-maintained mode	
Power factor	>0.5	
LED lifespan	50,000 hrs	
Standard	60598-2-22:2021	
Emergency change over	<0.5S	
Emergency Pack	3.2V 1.5Ah LiFePO4 / 3.7V 2.0Ah Li-ion	
Emergency time	3 Hours	
Light Angle	120°	
Test	Manual test + self test	Manual+ Self Remote test
Charging indicator	Green	
Faulty indicator	RED	
Luminous Flux(AC)	300Lm	
Emergency power	1.5W	
Luminous Flux(DC/EM)	150Lm	

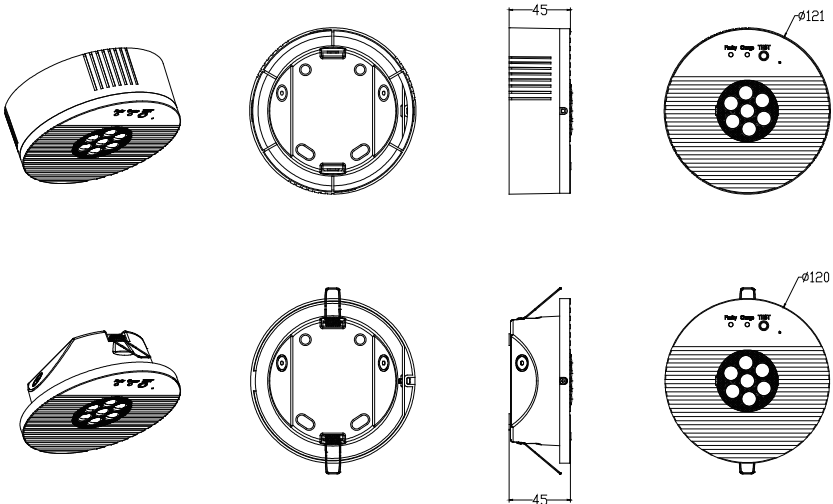

4 Maintained & non-maintained changeover

Maintained & Non-maintained work mode

The OT-ECL3-M series can work both in maintained and non-maintained mode.

Wiring it in right way according the installation request.

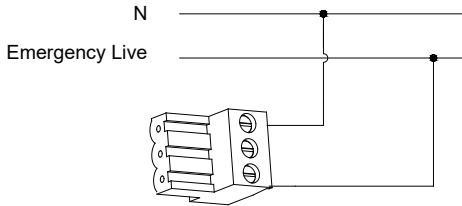

Wiring 1: Non-maintained Mode

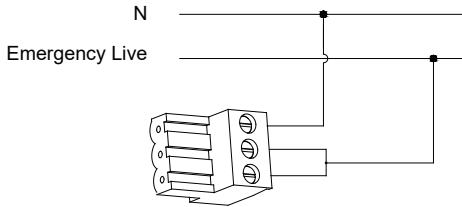

Wiring 2: Maintained Mode

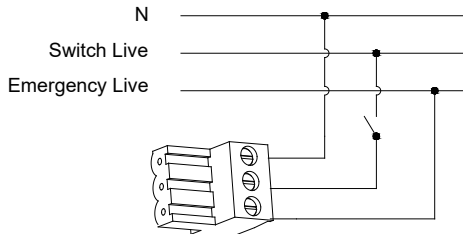

Wiring 3: Switch- Maintained Mode

5 Self-test system

5.1 Testing (If no failure)

5.1.1. Manual function test.

OT-ECL3-M-ST/RST: Active the ④ test button.

OT-ECL3-M-RST: Press "TEST" switch on controller.

- a) The ② Charging indicator OFF.
- b) The Emergency function ON.
- c) The test will cut off the mains

5.1.2 Monthly test.

OT-ECL3-M-ST/RST: Active the ④ test button for 5 second;

OT-ECL3-M-RST: Press "Monthly TEST" switch on controller.
or the lamp installed every 30 days.

- a) The ② Charging indicator will flash in 1Hz for 128s;
- b) The Emergency function ON;
- c) The test finished and back to standby mode.

5.1.3 Annual test.

OT-ECL3-M-ST/RST: Active the ④ test button for 7 second;

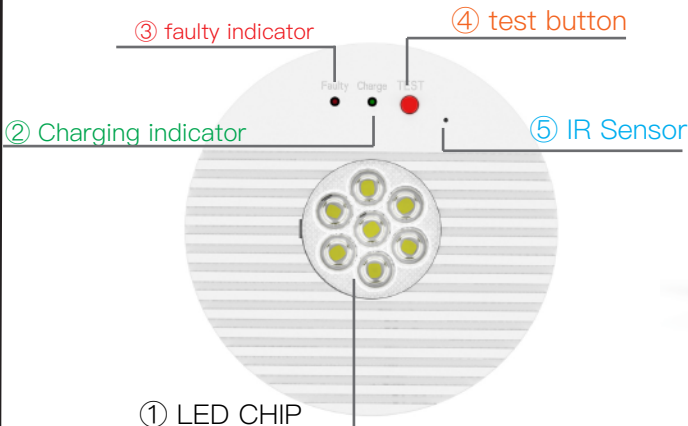

OT-ECL3-M-ST: Press "Annual TEST" switch on controller.
or the lamp installed every 180 days.

- a) The ② Charging indicator will flash in 2Hz for 3hours;
- b) The charging will be cut off & emergency function ON 3hours;
- c) The lamp back to standby mode after test.















Remote test controller
OT-ECL3-RST only

5.2 Testing (If any failure)

- 5.2.1 Battery failure: 
 Monitored every 1 hour. The ③ faulty indicator will flash in 1 Hz if the battery failure.
- 5.2.2 LED load failure: 
 If press test button, or the luminary self-monthly test. The ③ faulty indicator will flash in 2 Hz if LED load failure.
- 5.2.3 Duration failure: 
 Only in Annual self-test. The ③ faulty indicator will turn on constantly if the Battery can not last 3 hours

6 Emergency control logic

The emergency function control logic

Operation	Charging indicator		Faulty Indicator (RED)		Emergency LED Maintained mode		Emergency LED Non-Maintained	
	1 S	1 S	1 S	1 S	1 S	1 S	1 S	1 S
Time line (Second)								
Normal charging			OFF		Constantly on		OFF	
Normal full charged	Constantly on		OFF		Constantly on		OFF	
Normal AC Failure	OFF		OFF		Constantly on		Constantly on	
Manual test	OFF		OFF		Constantly on		Constantly on	
Monthly self-test			OFF		Constantly on		Constantly on	
Annual self-test					OFF		Constantly on	
Battery circuit failure	OFF				Constantly on		OFF	
Light source failure	Constantly on						OFF	
Duration test failure	Constantly on		Constantly on		Constantly on		OFF	



Before



After

No Key switch, No Harry, No ladders
 Safe / Easy / Convenient

7 Emergency function & Wiring

ADDITIONAL INFORMATION - COMPONENT REPLACEMENT

- The luminaire contains no user replaceable components other than the battery pack contained in emergency versions.
- The battery has a 4 year service life provided it is operated and maintained by regular testing, as detailed in this User manual. Failure to maintain or change the battery may result in reduced duration in emergency mode.

Emergency function test before installation

1. Connect the ① **AC supply** cable According Dia 1 , Keep S1 OFF.
 - The charging indicator off,
 - The Faulty indicator flash in 1hz.
2. ② **Battery plug** on and press the test button.
 - The charging indicator on,
 - The Faulty indicator stop flashing.
 - The emergency light work in non-maintained mode.
3. Press the test button, The charging indicator off, and emergency function actived.
4. S1 Switch on, The emergency light work in Maintained Mode
5. Cut off the AC power supply, The Charging indicator off and emergency function on.

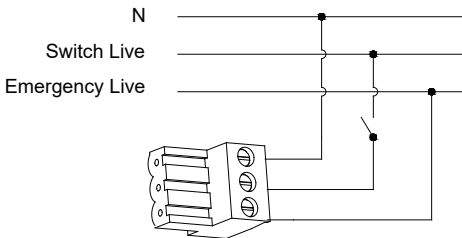

Dia.1

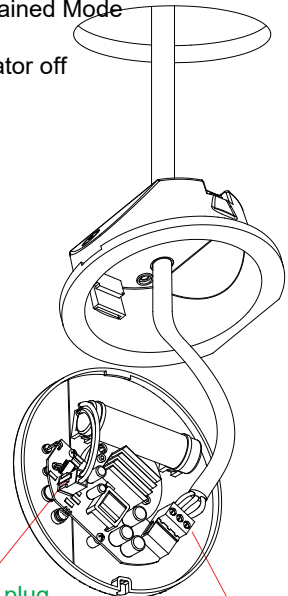

② Battery plug

① AC supply



Caution

1. All OTC LED bulkheads are designed for projects. Only qualified electrician can install or maintain it.
2. The mains have to be off during the installation or maintenance.
3. Keep the product far from heat sources and in a well ventilated area.

Recessed Mounting

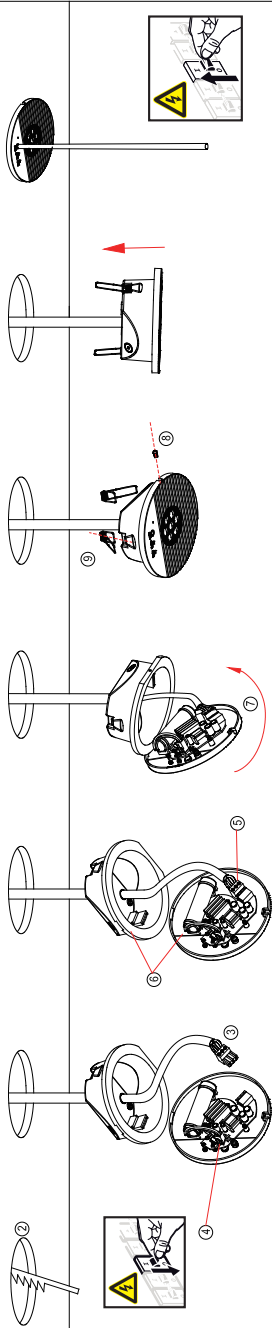

1. Make sure the Mains OFF
2. Saw a round hole (D95-100mm) on ceiling.
3. Wiring the Power cable
4. Plug in the battery
5. Plug in the main power plug
- 6/7. Install the cap to base by clips
8. Fix the cap by the screws
9. Press in the screws
10. Install the luminaire into the ceiling
11. Switch mains on
12. Press the test button.

Ceiling Mounting

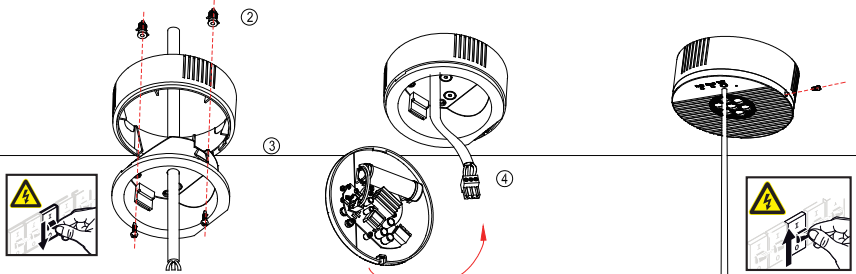

1. Make sure the Mains OFF
2. drill the screw hole on ceiling.
3. Install the based and decoration trim on to ceiling.

4. Wiring and install cap same as recessed mounting.
5. Switch mains on
6. Press the test button .

11 EM inspection record table



Luminaire emergency inspection record

month	Test	First Year		Second Year		Third Year		Fourth Year		Fifth Year	
		Signed	Date	Signed	Date	Signed	Date	Signed	Date	Signed	Date
1	Functional										
2	Functional										
3	Functional										
4	Functional										
5	Functional										
6	1 hour										
7	Functional										
8	Functional										
9	Functional										
10	Functional										
11	Functional										
12	3 hours										

Installed By: Installed Date: LuminaireNO.:

Luminaire Location: Contact details: