



TECHNOLOGY

# USER MANUAL



# T-ART/G2+ TELEPHONE

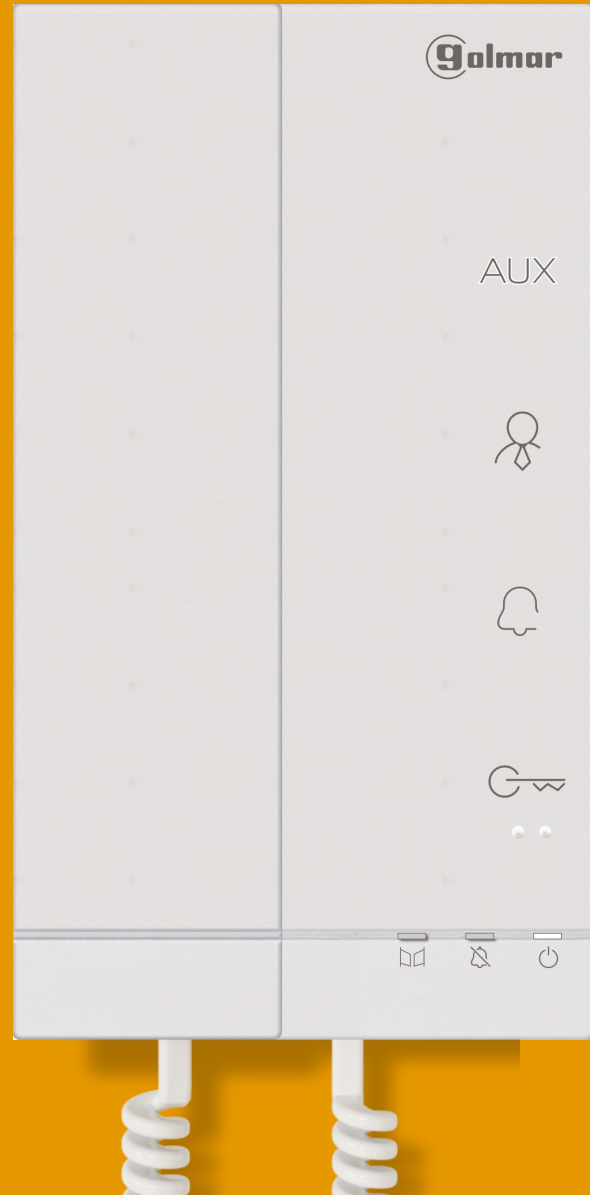

## INTRODUCTION

---

First of all, we thank and congratulate you for purchasing this product.

Our commitment to achieving the satisfaction of customers like you is manifested through our ISO-9001 certification and the manufacture of products like the one you have just purchased.

Its advanced technology and strict quality control will ensure that customers and users enjoy the numerous features that this device offers. To get the most out of them and ensure proper operation from day one, we recommend that you read this instruction manual.

## CONTENTS

---

Introduction.....	2
Contents.....	2
Safety precautions.....	2
Characteristics.....	3
System operation.....	3
Description of the T-ART/G2+ telephone.....	
Description.....	4
Function buttons.....	4
Status LED.....	4
Label product.....	4
Connection terminals.....	4
DIP switch.....	5
Configuration of telephone address codes (up to 128 addresses).....	5-8
Autoswitch-on function.....	9
Intercom function.....	9
Automatic door opening mode.....	9
Light activation function (staircase light).....	9
Setting audio volume in the telephone.....	9
Setting call tone volume & 'Do not disturb' mode function.....	9
Configuration & selection of the call tone.....	10
Tones & volume call tones to 'default value':.....	10
Cancel the 'call forwarding' process.....	10
T-ART/G2+ telephone installation.....	
In wall mounting connector.....	11
In embedding box.....	12
Wiring diagrams.....	13
Cleaning the monitor.....	14
Notes.....	15
Compliance.....	16



## SAFETY PRECAUTIONS

---

- **Always disconnect the power supply** before making modifications to the device.
- The fitting and handling of these devices must be carried out by **authorised personnel**.
- The wiring must run at least **40cm away from any other wiring**.
- Do not overtighten the screws on the connector.
- Install the T-ART/G2+ telephone in a dry protected location free from the risk of dripping or splashing water.
- Do not place in humid, dusty or smoky locations, or near sources of heat.
- Before connecting the device to the mains, check the connections between the door panel, power supply & T-ART/G2+ telephones.
- Always follow the instructions contained in this manual.











## CHARACTERISTICS

---

- T-ART telephone with simplified installation (non-polarised 2 wire bus).
- Up to 4 T-ART telephones/monitors per apartment (master, slave 1, slave 2 and slave 3).
- Up to 32 apartments/T-ART telephones in mixed installations with monitors (**EL632 G2+ SE module**).
- Up to 128 apartments/T-ART telephones per installation (**EL642 G2+ sound module required**).
- Completely private conversation.
- Call reception volume control: min, med, max and off (do not disturb).
- Audio volume control during communication process (4 different levels).
- "HZ" input for calls from apartment front door.
- Output to auxiliary call repeater (maximum 50mA/12Vdc).
- Up to 6 different ringtones to identify the origin of the call (door panel, intercom, guard monitor or front door of the apartment).
- Button  for lock release 1 activation/ activate/ deactivate "Doctor mode".
- Button **AUX** for lock release 2 activation/ staircase light activation (SAR-G2+ & SAR-12/24 modules required)/ "intercom" calls (within the same apartment) and "autoswitch-on" function.
- Button  for tone call volume control, "do not disturb" mode/ configuring ringtones/ communication call volume control (T-ART speaker).
- Button  for guard monitor calls (if exist).
- DIP switches for setting the telephone's address (call code), master/slave and end of line.

## SYSTEM OPERATION

---

- To make a call, the visitor needs to press the button for the apartment, an audible tone indicates that the call is being made and LED  on the door panel illuminates. If vocal synthesis is enabled, a 'Call is in progress' message appears indicating that a call is being made. At this moment, the apartment's telephone(s) receives the call. If another apartment is called by mistake, press the button for the correct apartment and the first call will be cancelled.
- Upon receiving the call, the telephone's LED  will blink white. If the call is not answered within 40 seconds, the door panel's LED  will turn off, the telephone's LED  switch on (white color) and the channel will be freed.
- To establish communication, lift the handset on any telephone in the apartment. Door panel's LED  will turn off, the led  will turn on and the telephone's LED  switch on (white color).
- Communication will last for one and a half minutes or until the handset is replaced. When communication has finished, door panel's LED  will turn off and the channel will be freed. If vocal synthesis is enabled, a 'Communication is finished' message will indicate that the call is over.
- To open the door, press button  (if it exists and, to open the second door, press button **AUX** ) during the call or communication processes: one press activates the lock release for 3 seconds and LED  on the door panel will also illuminate for 3 seconds. If vocal synthesis is enabled, a 'Door is open' message will be indicated on the door panel.
- Description of the function buttons can be found on p. 4.

TELEPHONE DESCRIPTION:

**Description:**

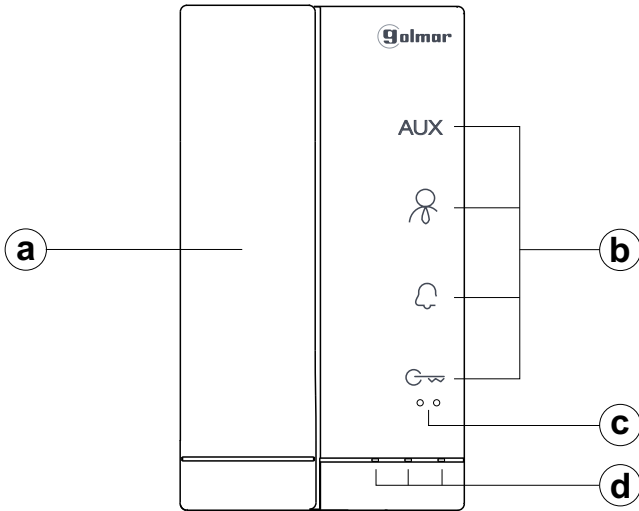

- a. Handset.
- b. Function push buttons.
- c. Raised dots for the visually impaired people.  
 In call/ communication:  
 ●● Above these raised dots is the "Door opening" button.
- d. Status Leds.

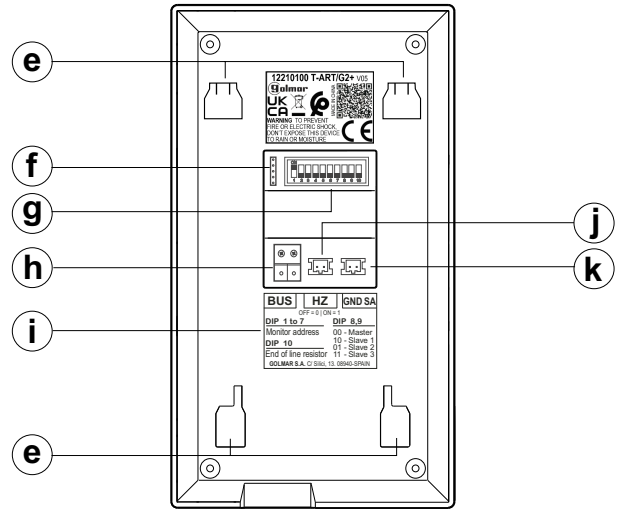

- e. Wall mounting connector fixing (x4).
- f. Gol,ar use.
- g. Configuration switches.
- h. Bus connection terminals.
- i. Label.
- j. Apartment front door button input "HZ".
- k. Auxiliary call repeater output (máx. 50mA/12Vdc).

**Funtion push button:**

- In standby (handset off the hook):** one short press for guard monitor calls (if exist). See pages 9-10.
- AUX** During the call or communication processes: one press will activate the lock release 2. **In standby (handset on the hook):** press the button for 3 sec. to activate the staircase light (the SAR-G2+ & SAR-12/24 modules required). With V05 and later, 5 short press to default tones & tones volume (led switch on for 2 sec.). **In standby (handset off the hook):** 2 short press to "intercom" call (within the same apartment) and press for 3 sec. to "autoswitch-on" function. See pages 9-10.
- During the call or communication processes:** one press will activate the lock release 1. **In standby (handset on or off the hook):** **Note:** With V05 or later, press the button for 8 sec. to activate/deactivate the "Doctor mode" function. See pages 9-10.
- In standby (handset on the hook):** short press, it allows to change tone call volume, on every short press telephone reproduces the selected volume (cyclic min/ med/ max/ off "do not disturb"). **In communication:** on every short press, it allows to change the speaker of the T-ART audio volume (cyclic 4 audio levels). See pages 9-10.

**Funtion status LED:**

- During call door panel, guard or intercom process: Led will blink (white color).  
 telephone in communication: Led switch on (white color).
- "Do not disturb" mode: Led switch on (red color).  
 (Call forwarding) smartphone communication with the door panel from G2call+ App (with ART 7W monitor): Led blink (red color).  
 "Default tones, tones volume & doctor mode": Led switch on for 2 sec. (red color).
- "Doctor mode": Led switch on (red color).

**Label product:**



**Description connection terminals:**

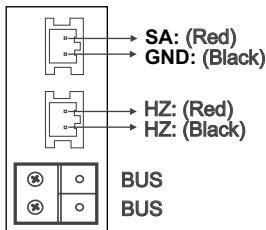

- BUS, BUS: Communication BUS (non-polarised).
- SA, GND: Auxiliary call repeater output (max 50mA/12Vdc), relay SAR-12/24.
- HZ, HZ: Apartment front door button input:  
 Connect only on the master monitor. The signal received is then transmitted to the slave monitors in the same apartment through the BUS.

**Note:** HZ push button function mode: When HZ push button is pressed will be call tone and activate the output of auxiliary call repeater with standby telephone, call process, communication process (HZ tone with lower audio level), intercom process and "Do not disturb" mode. **Important:** Up to 8 telephones/ apartments with push button "HZ" activated at the same time (with system and telephones in standby).

**TELEPHONE DESCRIPTION:**

**Description of the DIP switch and configuration of the T-ART/G2+ telephone address (code):**

**Edificio / Chalet (Placa Nexa)**

**Dip1-Dip7:** Sets the telephones address (addresses 1 to 128). **Note:** Mixed installations with monitors (addresses 1 to 32). The switches set to OFF have a zero value. The values of the switches set to ON are shown in the table below. The telephone code is the sum of the values of the switches set to ON.

**Important:**

Apartment 1 (Dip1 to ON & Dip2-Dip7 to OFF)  
 Apartment 128 (Dip1-Dip7 to OFF)

**Table of values**

Switch number:	1	2	3	4	5	6	7
Value when ON:	1	2	4	8	16	32	64



Example: 0+0+4+0+16+0+0= 20

**Dip8-Dip9:** These define whether the telephone is master or slave. Each apartment must have only one master telephone.

**Master**



**Slave 1**



**Slave 2**



**Slave 3**



**Dip10:** Configures the end of line. In installations with telephones only, it must always be in the OFF position. In mixed installations of monitors with T-ART/G2+ telephones in the same apartment, set to ON for the telephones in which the BUS cable ends and leave in the OFF position for intermediate telephones.

**IMPORTANT:** T-ART/G2+ telephone in **Villa installation with SOUL door panel**, see corresponding Kit Soul user manual for Kit features as maximum number of apartments and monitors/ART 1 G2+ telephone.

**Configuration of T-ART/G2+ telephone address codes (up to 128 addresses):**

**Important:**

- Up to 32 apartments/T-ART telephones in mixed installations with monitors (**EL632 G2+ SE module**).
- Up to 128 apartments/T-ART telephones per installation (**EL642 G2+ sound module required**).

**Dip1 a Dip7:** To configure the T-ART/G2+ telephone/apartment address (up to 128 addresses).

**Apartment code 1**



**Apartment code 2**



**Apartment code 3**



**Apartment code 4**



**Apartment code 5**



**Apartment code 6**



**Apartment code 7**



**Apartment code 8**



**Apartment code 9**



**Apartment code 10**



**Apartment code 11**



**Apartment code 12**



**Apartment code 13**

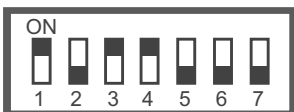

**Apartment code 14**

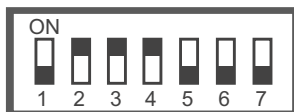

**Apartment code 15**

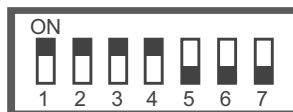

**Apartment code 16**

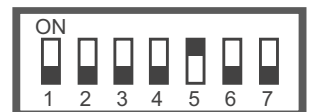

**Apartment code 17**



**Apartment code 18**



**Apartment code 19**



**Apartment code 20**



TELEPHONE DESCRIPTION:

Continued from previous page.

Apartment code 21



Apartment code 22



Apartment code 23



Apartment code 24

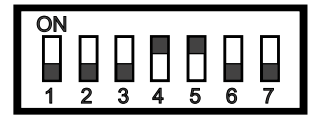

Apartment code 25

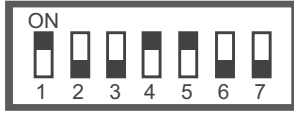

Apartment code 26



Apartment code 27



Apartment code 28

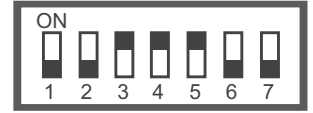

Apartment code 29



Apartment code 30



Apartment code 31



Apartment code 32



Apartment code 33

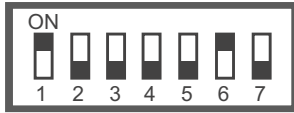

Apartment code 34

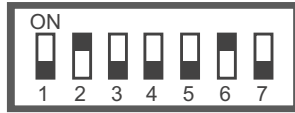

Apartment code 35



Apartment code 36



Apartment code 37



Apartment code 38



Apartment code 39



Apartment code 40



Apartment code 41



Apartment code 42



Apartment code 43



Apartment code 44



Apartment code 45



Apartment code 46

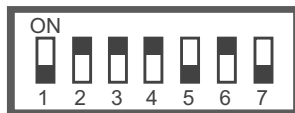

Apartment code 47



Apartment code 48



Apartment code 49



Apartment code 50



Apartment code 51



Apartment code 52



Apartment code 53

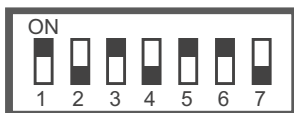

Apartment code 54

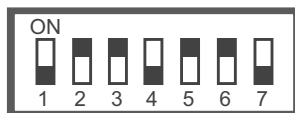

Apartment code 55



Apartment code 56



Apartment code 57



Apartment code 58



Apartment code 59



Apartment code 60



Apartment code 61

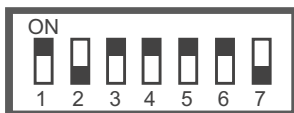

Apartment code 62

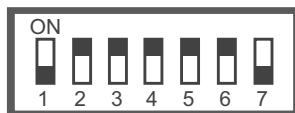

Apartment code 63







































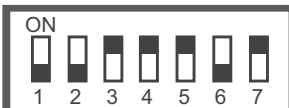
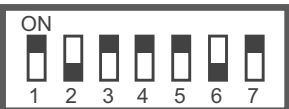
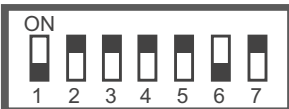
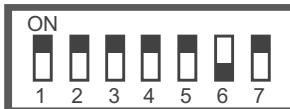

Apartment code 64

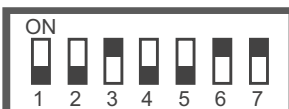

Continued overleaf

TELEPHONE DESCRIPTION:

Continued from previous page.

<b>Apartment code 65</b> 	<b>Apartment code 66</b> 	<b>Apartment code 67</b> 	<b>Apartment code 68</b> 
<b>Apartment code 69</b> 	<b>Apartment code 70</b> 	<b>Apartment code 71</b> 	<b>Apartment code 72</b> 
<b>Apartment code 73</b> 	<b>Apartment code 74</b> 	<b>Apartment code 75</b> 	<b>Apartment code 76</b> 
<b>Apartment code 77</b> 	<b>Apartment code 78</b> 	<b>Apartment code 79</b> 	<b>Apartment code 80</b> 
<b>Apartment code 81</b> 	<b>Apartment code 82</b> 	<b>Apartment code 83</b> 	<b>Apartment code 84</b> 
<b>Apartment code 85</b> 	<b>Apartment code 86</b> 	<b>Apartment code 87</b> 	<b>Apartment code 88</b> 
<b>Apartment code 89</b> 	<b>Apartment code 90</b> 	<b>Apartment code 91</b> 	<b>Apartment code 92</b> 
<b>Apartment code 93</b> 	<b>Apartment code 94</b> 	<b>Apartment code 95</b> 	<b>Apartment code 96</b> 
<b>Apartment code 97</b> 	<b>Apartment code 98</b> 	<b>Apartment code 99</b> 	<b>Apartment code 100</b> 
<b>Apartment code 101</b> 	<b>Apartment code 102</b> 	<b>Apartment code 103</b> 	<b>Apartment code 104</b> 
<b>Apartment code 105</b> 	<b>Apartment code 106</b> 	<b>Apartment code 107</b> 	<b>Apartment code 108</b> 

Continued overleaf





**TELEPHONE DESCRIPTION:****Autoswitch-on function:**

With the T-ART/G2+ telephone in standby mode and the handset off the hook, you can establish an audio communication with the master door panel. It is only operative if there is no communication in progress.

With the telephone in standby mode and handset off the hook, press the button **AUX** for 3 seconds, a confirmation tone will sound on the telephone, indicating that audio communication has been established with the master door panel.

The communication will last for one and a half minutes or until the handset is replaced.

**Intercom function:**

Intercom functionality between two points in the same apartment comes as standard with the T-ART/G2+ telephone.

The telephone must be in standby and the handset off the hook to make intercom calls.

To make an intercom call, press button **AUX** two short times, the led  of the telephone that makes the intercom call and the telephones that receive the call will blink and some tones in the apartment telephones will confirm that the call is being made.

The call needs to be answered within 40 seconds.



To establish communication, pick up the handset of any called telephone of the apartment (if there is more than one slave telephone), the led  of the telephones in communication and the rest of the telephones of the apartment will turn on.

Communication will last for one and a half minutes or until the handse is replaced.



**"Automatic door opening" mode:**

The T-ART/G2+ telephone allows you to activate/deactivate the "automatic door opening" mode.

Activate "automatic door opening" mode:

**Note:** With V05 or later, with the telephone in standby mode (handset on or off the hook), press the button  for 8 sec., a confirmation tone will sound and the led  on the telephone will turn on (red), indicating that the "automatic door opening" mode has been activated, (3 seconds after a call from the door panel).

Deactivate "automatic door opening" mode

**Note:** With V05 or later, with the telephone in standby mode (handset on or off the hook), press the button  for 8 sec., a confirmation tone will sound and the led  on the telephone will turn off, indicating that the "automatic door opening" mode has been deactivated.

**Light activation function:**

The T-ART/G2+ telephone must be in standby (handset off the hook) for light activation (requires SAR-G2+ and SAR-12/24 module). **Important:** For connection and configuration, see TSAR-G2+ and TSAR-12/24 manual.

To activate the light (e.g. "staircase light"), press the button **AUX** for 3 seconds until you hear a confirmation tone indicating that the light has been activated.



**Setting audio volume in the telephone:**

The telephone allows you to change the volume of the audio in the speaker of the communicating telephone (between 4 levels from minimum to maximum in carousel mode) through the function button .



The telephone must be in communication, a short press on the button , allows to change the audio volume on the telephone speaker, each short press reproduces the selected volume (between 4 levels from minimum to maximum and in carousel mode), stop pressing once the desired volume level is selected on the telephone. When communication has finished, the selected volume will be saved in the telephone.

**Setting call tone volume & 'Do not disturb' mode function:**

The telephone must be in standby (handset off the hook) to adjust the volume of the call tone or to activate/deactivate the "do not disturb" mode.

A short press on the button  allows you to change the volume of the call tone, each short press reproduces the selected volume (minimum/ medium/ maximum and no volume in "do not disturb" mode), stop pressing once the "do not disturb" mode has been selected (the LED on the button  turn on in red) or the volume of the desired call tone.

If the "do not disturb" mode has been selected, the LED on the button  will turn on (red), indicating that the "do not disturb" mode is active. The telephone will not sound the ring tone when a call is received (see note "HZ" on page 4).

To deactivate the "do not disturb" mode, press the button , each short press reproduces the selected volume (minimum/ medium/ maximum and no volume "do not disturb" mode), stop pressing once the volume (minimum/ medium or maximum) of the desired call tone has been selected; the LED  will turn off indicating that the "do not disturb" mode is deactivated.

Continued overleaf

**TELEPHONE DESCRIPTION:**

Continued from previous page.

**Configuration & selection of the call tone:**

The telephone must be in standby (handset off the hook) for the configuration and selection of the desired call tone.

To modify the call tones, press the button  for 3 seconds until you hear 2 confirmation tones that indicate that the telephone is in configuration mode. Once in configuration mode, press the corresponding button to change the call tone (between 6 different ring tones and in carousel mode):

- To change the "apartment front door button" (HZ) call tone, press the button **AUX**.

Each short press on the button **AUX** reproduces a different call tone, stop pressing once you have selected the desired "apartment front door button" call tone on the telephone.

- To change the "intercom" call tone, press the button .

Each short press on the button  reproduces a different call tone, stop pressing once you have selected the desired "intercom" call tone on the telephone.

- To change the "guard monitor" call tone, press the button .

Each short press on the button  reproduces a different call tone, stop pressing once you have selected the desired "guard monitor" call tone on the telephone.

- To change the door panel call tone, press the button .

Each short press on the button  reproduces a different call tone, stop pressing once you have selected the desired door panel call tone on the telephone.

To exit and save the selected call tone in the telephone, press the button  for 3 seconds until you hear 2 confirmation tones indicating that the telephone has saved and left the configuration mode.

Make a call to check that the telephone has been configured with the desired call tones.

**Tones, volume call tones & doctor mode default value:**

The T-ART/G2+ telephone allows you to restore the tones, volume of the call tones and doctor mode to "default value".

With the telephone in standby (handset off the hook), 5 short presses on the button **AUX**, some confirmation tones and the led  of the telephone will switch on for 2 seconds, indicating that the tones, volume of the call tones and doctor mode in the telephone have been restored to their default value.

**Cancel the 'call forwarding' process or 'communication' with door panel from G2Call+ App:**

-If a call is made from the door panel to an apartment of a mixed video door entry system (ART 7W/G2+ monitors and T-ART/G2+ telephones in the same apartment) and the ART 7W/G2+ monitor has "call forwarding" configured and activated; from an T-ART/G2+ telephone in the same home, you can cancel the process of "call forwarding" to an smartphone by picking up the telephone handset (information about this function, see the TART 7W G2+ manual).

-If smartphone is in communication with door panel from G2Call+ App, you can cancel the communication process to an smartphone by pressing the button  on the telephone for more than 3 seconds (information about this function, see the TART 7W G2+ manual).

## INSTALLING THE TELEPHONE IN A WALL MOUNTING CONNECTOR:

Avoid dusty or smoky environments or locations near sources of heat.

### **Positioning the wall mounting connector:**

The top of the wall mounting connector should be located at a height of 1.60m from the ground. The minimum distance between the wall mounting connector and the closest object must be 5 cm.

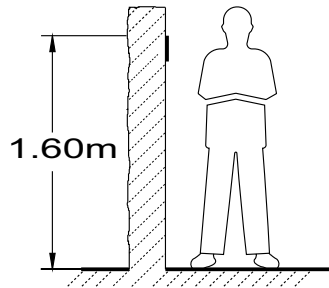

### **Fixing the telephone's wall mounting connector to the wall:**

Fix the telephone's wall mounting connector to the wall by drilling two 6mm diameter holes and using the screws and plugs supplied with the telephone.

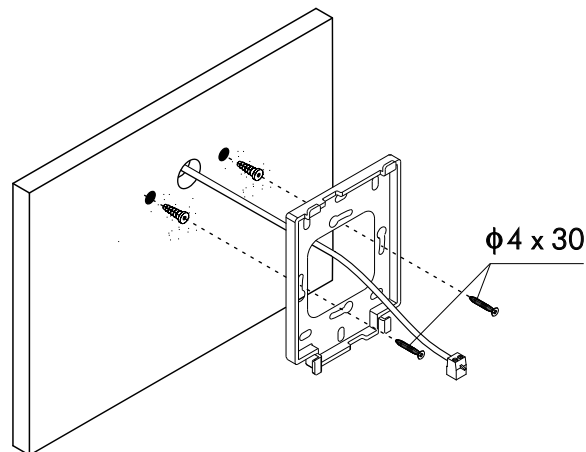

### **Positioning the telephone:**

Connect the cables to the telephone (see p. 4), position the telephone in front of the wall mounting connector, ensuring that the holes in the base of the telephone line up with those on the connector ①, and then move the telephone downwards ② until the telephone is securely fixed to the connector ③.

Remember to remove the protective covering from the front of the telephone once installation has been completed.

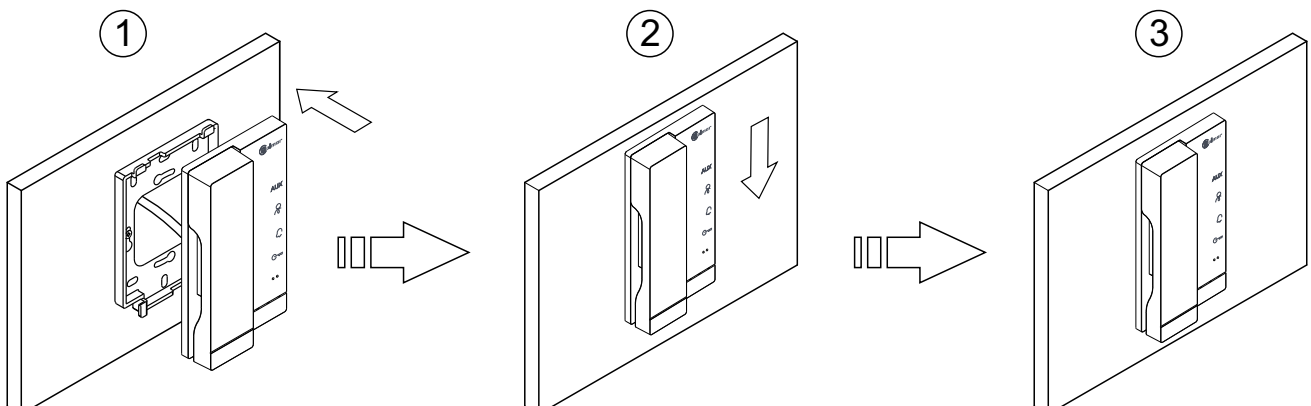

## INSTALLATION OF THE TELEPHONE IN AN EMBEDDING BOX:

Avoid dusty or smoky environments or locations near sources of heat.

### **Positioning the embedding box:**

Make a hole in the wall to position the top of the universal embedding box at a height of 1.60 m from the ground. The minimum distance between the sides of the embedding box and the closest object must be 5 cm.

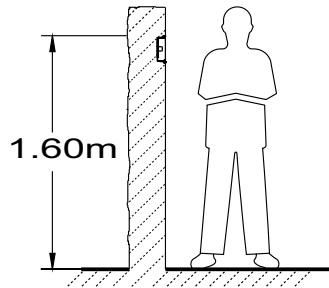

### **Positioning the embedding box and fitting the wall mounting connector:**

Pass the cable through the hole made in the embedding box. Embed the box and ensure that it is level and flush. Fix the wall mounting connector of the telephone to the embedding box with the screws supplied.

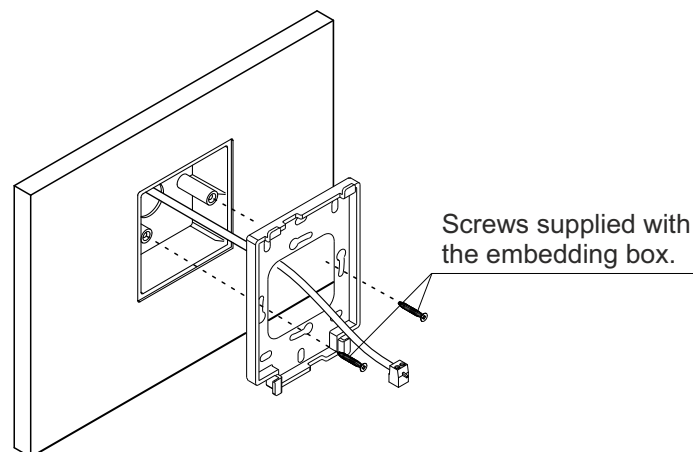

### **Positioning the telephone:**

Connect the cables to the telephone (see p. 4), position the telephone in front of the wall mounting connector, ensuring that the holes in the base of the telephone line up with those on the connector ①, and then move the telephone downwards ② until the telephone is securely fixed to the connector ③.

**Remember to remove the protective covering from the front of the telephone once installation has been completed.**

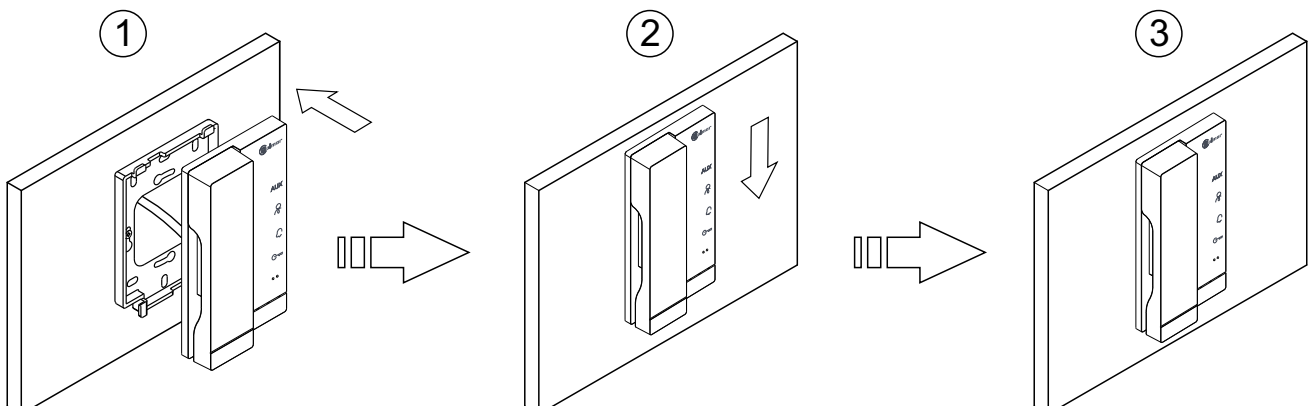

WIRING DIAGRAMS:

**Audio door entry system with 128 apartments / T-ART-G2+ telephones and Golmar d.c lock release.**

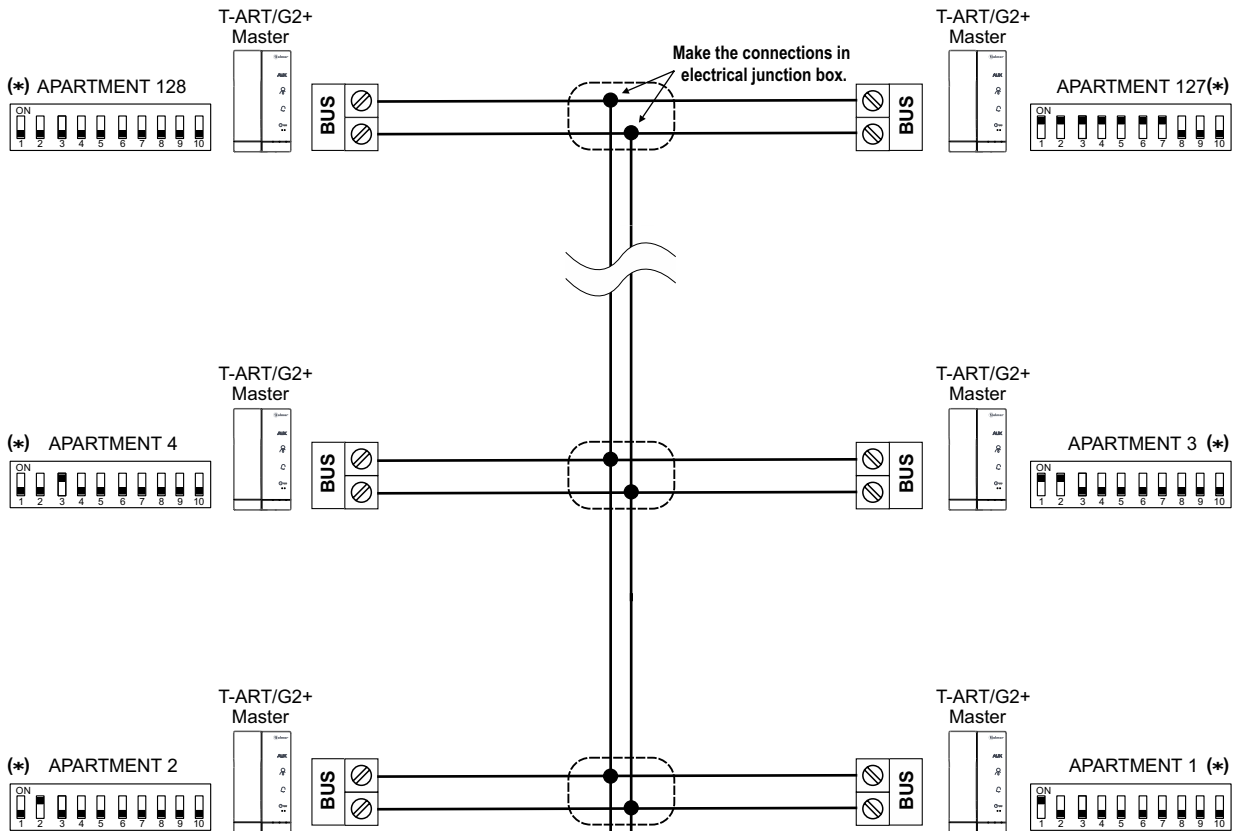

**Distances and cross-sections:**

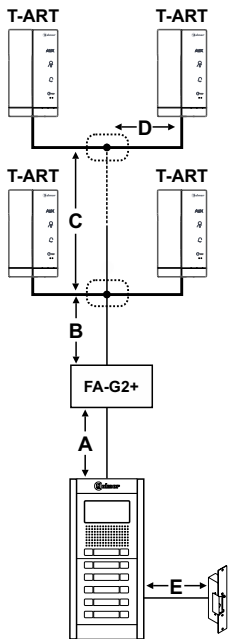

Cable	A	B	C	D	B+C+D	E
RAP-GTWIN/HF 2x1mm <sup>2</sup>	80m	20m	96m	15m	130m	15m

**Important:**  
 B: must be ≤ to 20m.  
 D: must be ≤ to 15m.

**Access door panel**

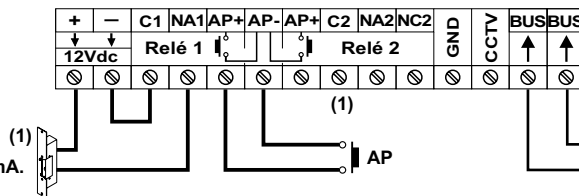
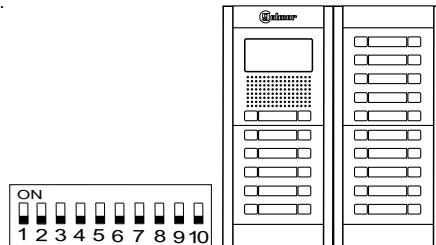

(\*) Only audio installation, configure the end of line Dip 10 to OFF in all telephones.

(1) For more information about the door panel, installation, configuration, connection of an AC lock release, 2nd lock release, mixed installation with monitors and T-ART/G2+ telephones and other wiring diagrams, (see the corresponding door panel manual).

**CLEANING THE TELEPHONE:**

---

- Do not use solvents, detergents or cleaning products that contain acids, vinegar or abrasive components.
- Use a soft damp lint-free cloth with water.
- Always wipe the telephone in the same direction, from top to bottom.
- After cleaning the telephone, remove any moisture with a soft dry lint-free cloth.

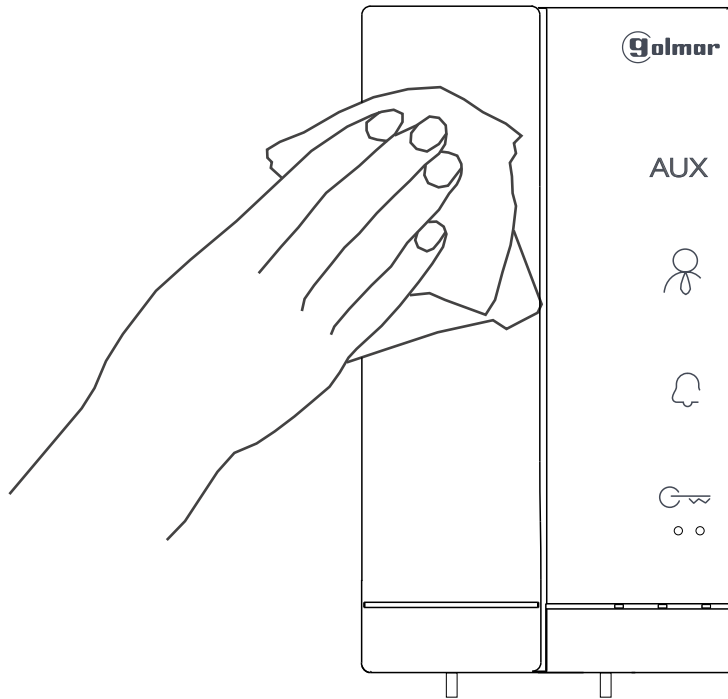



**COMPLIANCE:**

Este producto es conforme con las disposiciones de las Directivas Europeas aplicables respecto a la Compatibilidad Electromagnética **2014/30/CEE**.

*This product meets the essentials requirements of applicable European Directives regarding Electromagnetic Compatibility **2014/30/ECC**.*



**NOTA:** El funcionamiento de este equipo está sujeto a las siguientes condiciones:

(1) Este dispositivo no puede provocar interferencias dañinas, y (2) debe aceptar cualquier interferencia recibida, incluyendo las que pueden provocar un funcionamiento no deseado.

**NOTE:** Operation is subject to the following conditions:

(1) This device may not cause harmful interference, and (2) this device must accept any received interference, including the ones that may cause undesired operation.



golmar@golmar.es

www.golmar.es

GOLMAR S.A.  
C/ Silici, 13  
08940- Cornellá de Llobregat  
SPAIN



Golmar se reserva el derecho a cualquier modificación sin previo aviso.

Golmar se réserve le droit de toute modification sans préavis.

Golmar reserves the right to make any modifications without prior notice.