



TECHNOLOGY



ART 1 G2+ TERMINAL

USER MANUAL



INTRODUCTION

First of all, we thank and congratulate you for purchasing this product.

Our commitment to achieving the satisfaction of customers like you is manifested through our ISO-9001 certification and the manufacture of products like the one you have just purchased.

Its advanced technology and strict quality control will ensure that customers and users enjoy the numerous features that this device offers. To get the most out of them and ensure proper operation from day one, we recommend that you read this instruction manual.





CONTENTS

Introduction.....	2
Contents.....	2
Safety precautions.....	2
Characteristics.....	3
System operation.....	3
Description of the ART 1/G2+ terminal.....	
Description.....	4
Function buttons.....	4
Push button status LED.....	4
Label product.....	4
Connection terminals.....	4
DIP switch.....	5
Configuration of terminal address codes (up to 128 addresses).....	5-8
Autoswitch-on function.....	9
Intercom function.....	9
Automatic door opening mode.....	9
Light activation function (staircase light).....	9
Setting audio volume in the terminal.....	9
Setting call tone volume & 'Do not disturb' mode function.....	9
Configuration & selection of the call tone.....	10
Tones & volume call tones to 'default value':.....	10
Cancel the 'call forwarding' process.....	10
ART 1/G2+ terminal installation.....	
In wall mounting connector.....	11
In embedding box.....	12
Wiring diagrams.....	13
Cleaning the monitor.....	14
Notes.....	15
Compliance.....	16











SAFETY PRECAUTIONS

- **Always disconnect the power supply** before making modifications to the device.
- The fitting and handling of these devices must be carried out by **authorised personnel**.
- The wiring must run at least **40cm away from any other wiring**.
- Do not overtighten the screws on the connector.
- Install the ART 1/G2+ terminal in a dry protected location free from the risk of dripping or splashing water.
- Do not place in humid, dusty or smoky locations, or near sources of heat.
- Before connecting the device to the mains, check the connections between the door panel, power supply & ART 1/G2+ terminals.
- Always follow the instructions contained in this manual.

CHARACTERISTICS

- ART 1 hands-free audio terminal with simplified installation (non-polarised 2 wire bus).
- Up to 4 ART 1 terminals/monitors per apartment (master, slave 1, slave 2 and slave 3).
- Up to 32 apartments/ART 1 terminals in mixed installations with monitors (**EL632 G2+ SE module**).
- Up to 128 apartments/ART 1 terminals per installation (**EL642 G2+ sound module required**).
- Completely private conversation.
- Call reception volume control: min, med, max and off (do not disturb).
- Audio volume control during communication process (4 different levels).
- "HZ" input for calls from apartment front door.
- Output to auxiliary call repeater (maximum 50mA/12Vdc).
- Up to 6 different ringtones to identify the origin of the call (door panel, intercom, guard monitor or front door of the apartment).
- Button  for starting/stopping communication. In standby: 2 short press to "intercom" calls (within the same apartment) and press for 3 seconds to "autoswitch-on" function.
- Button  for lock release 1 activation. In standby: activate/ deactivate "Doctor mode".
- Button **AUX** for lock release 2 activation/ staircase light activation (SAR-G2+ & SAR-12/24 modules required).
- Button  for tone call volume control, "do not disturb" mode/ configuring ringtones/ communication call volume control (ART 1 speaker).
- Button  for guard monitor calls (if exist).
- DIP switches for setting the terminal's address (call code), master/slave and end of line.

SYSTEM OPERATION

- To make a call, the visitor needs to press the button for the apartment, an audible tone indicates that the call is being made and LED  on the door panel illuminates. If vocal synthesis is enabled, a 'Call is in progress' message appears indicating that a call is being made. At this moment, the apartment's terminal(s) receives the call. If another apartment is called by mistake, press the button for the correct apartment and the first call will be cancelled.
- Upon receiving the call, the push button  LED of the terminal(s) will blink white. If the call is not answered within 40 seconds, LED  will turn off and the channel will be freed.
- To establish communication, press button  on any terminal in the apartment. Door panel LED  will turn off and the led  will turn on.
- Communication will last for one and a half minutes or until button  is pressed again. When communication has finished, door panel LED  will turn off and the channel will be freed. If vocal synthesis is enabled, a 'Communication is finished' message will indicate that the call is over.
- To open the door, press button  (if it exists and, to open the second door, press button **AUX**) during the call or communication processes: one press activates the lock release for 3 seconds and LED  on the door panel will also illuminate for 3 seconds. If vocal synthesis is enabled, a 'Door is open' message will be indicated on the door panel.
- Description of the function buttons can be found on page 4.

TERMINAL DESCRIPTION:

Description:

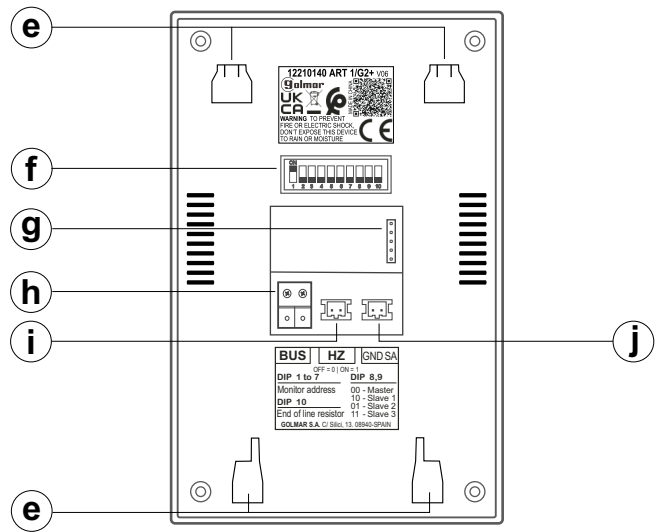
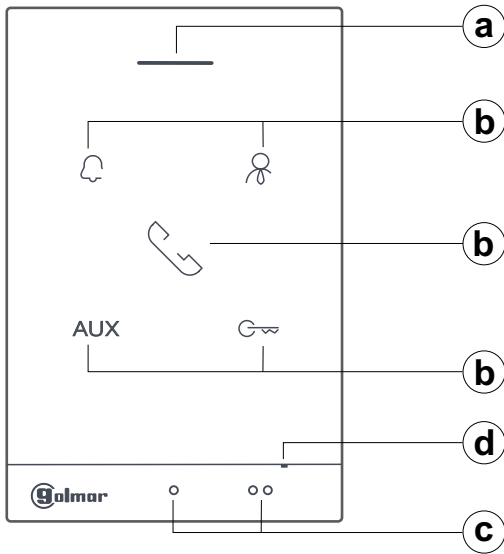

- a. Speaker.
- b. Function push buttons.
- c. Raised dots for the visually impaired people.
In call/ communication:
 - Above this raised dot is the "Start/ End communication" button.
 - Above these raised dots is the "Door opening" button.

- d. Microphone.
- e. Wall mounting connector fixing (x4).
- f. Configuration switches.
- g. Golmar use.
- h. Bus connections terminals.
- i. Apartment front door button input "HZ".
- j. Auxiliary call repeater output (max. 50mA/12Vdc).

Function push button:

- Start/stop communication button. In standby: 2 short press to "intercom" call (within the same apartment) and press for 3 seconds to "autoswitch-on" function. See page 9-10.
- In standby: short press, it allows to change tone call volume, on every short press terminal reproduces the selected volume (cyclic min/ med/ max/ off "do not disturb"). In communication: on every short press, it allows to change the speaker of the ART 1 audio volume (cyclic 4 audio levels). See p. 9-10.
- During the call or communication processes: one press will activate the lock release 1. In standby: **Note:** With V06 or later, press the button for 10 sec. to activate/deactivate the "Doctor mode" function. See page 9-10.
- AUX** During the call or communication processes: one press will activate the lock release 2. In standby: press the button for 3 sec. to activate the staircase light (the SAR-G2+ & SAR-12/24 modules required). 5 short press to default tones & tones volume (led blink 5 times). See page 9-10.

Function push button status LED:

- During call door panel, guard or intercom process: Led will blink (white color).
Terminal in communication: Led switch on (white color).
- "Do not disturb" mode: Led switch on (red color).
(Call forwarding)smartphone communication with door panel from G2call+ App (with ART 7W monitor): Led blink (red color).
"Default tones & tones volume": Led blink 5 times (red color).
- "Doctor mode": Led switch on (red color).

Label product:



Description connection terminals:

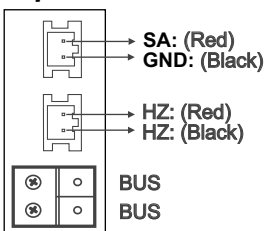

BUS, BUS: Communication BUS (non-polarised).
 SA, GND: Auxiliary call repeater output (max 50mA/12Vdc), relay SAR-12/24.
 HZ, HZ: Apartment front door button input:
 Connect only on the master monitor. The signal received is then transmitted to the slave monitors in the same apartment through the BUS.

Note: HZ push button function mode: When HZ push button is pressed will be call tone and activate the output of auxiliary call repeater with standby terminal, call process, communication process (HZ tone with lower audio level), intercom process and "Do not disturb" mode. **Important:** Up to 8 terminals/ apartments with push button "HZ" activated at the same time (with system and terminals in standby).

TERMINAL DESCRIPTION:

Description of the DIP switch and configuration of the ART 1/G2+ terminal address (code):

Edificio / Chalet (Placa Nexa)

Dip1-Dip7: Sets the terminals address (addresses 1 to 128). **Note:** Mixed installations with monitors (addresses 1 to 32). The switches set to OFF have a zero value. The values of the switches set to ON are shown in the table below. The terminal code is the sum of the values of the switches set to ON.

Importante:

Vivienda 1 (Dip1 a ON y Dip2-Dip7 a OFF)
 Vivienda 128 (Dip1-Dip7 a OFF)

Tabla de valores

Interruptor n°:	1	2	3	4	5	6	7
Valor en ON:	1	2	4	8	16	32	64



Ejemplo: 0+0+4+0+16+0+0= 20

Dip8-Dip9: These define whether the terminal is master or slave. Each apartment must have only one master terminal.

Master



Slave 1



Slave 2



Slave 3



Dip10: Configures the end of line. In installations with terminals only, it must always be in the OFF position. In mixed installations of monitors with ART 1/G2+ terminals in the same apartment, set to ON for the terminals in which the BUS cable ends and leave in the OFF position for intermediate terminals.

IMPORTANT: ART 1/G2+ terminal in **Villa installation with SOUL door panel**, see corresponding Kit Soul user manual for Kit features as maximum number of apartments and monitors/ART 1 G2+ terminals.

Configuration of ART 1/G2+ terminal address codes (up to 128 addresses):

Important:

















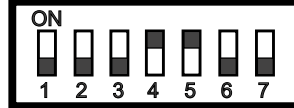



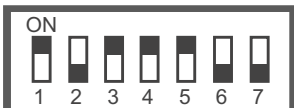
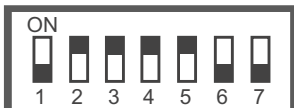
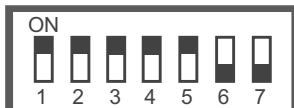



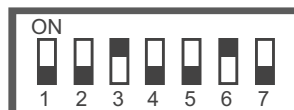









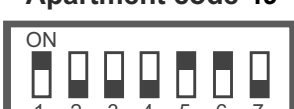

- Up to 32 apartments/ART 1 terminals in mixed installations with monitors (**EL632 G2+ SE module**).
- Up to 128 apartments/ART 1 terminals per installation (**EL642 G2+ sound module required**).

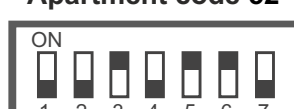
Dip1 a Dip7: To configure the ART 1/G2+ terminal/apartment address (up to 128 addresses).

Apartment code 1	Apartment code 2	Apartment code 3	Apartment code 4
Apartment code 5	Apartment code 6	Apartment code 7	Apartment code 8
Apartment code 9	Apartment code 10	Apartment code 11	Apartment code 12
Apartment code 13	Apartment code 14	Apartment code 15	Apartment code 16

TERMINAL DESCRIPTION:











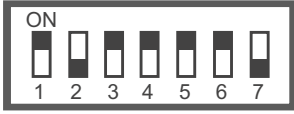





















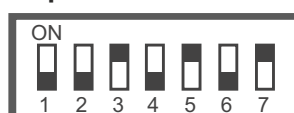









Continued from previous page.

Apartment code 17 	Apartment code 18 	Apartment code 19 	Apartment code 20 
Apartment code 21 	Apartment code 22 	Apartment code 23 	Apartment code 24 
Apartment code 25 	Apartment code 26 	Apartment code 27 	Apartment code 28 
Apartment code 29 	Apartment code 30 	Apartment code 31 	Apartment code 32 
Apartment code 33 	Apartment code 34 	Apartment code 35 	Apartment code 36 
Apartment code 37 	Apartment code 38 	Apartment code 39 	Apartment code 40 
Apartment code 41 	Apartment code 42 	Apartment code 43 	Apartment code 44 
Apartment code 45 	Apartment code 46 	Apartment code 47 	Apartment code 48 
Apartment code 49 	Apartment code 50 	Apartment code 51 	Apartment code 52 
Apartment code 53 	Apartment code 54 	Apartment code 55 	Apartment code 56 
Apartment code 57 	Apartment code 58 	Apartment code 59 	Apartment code 60 

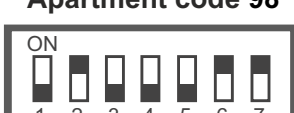
Continued overleaf

TERMINAL DESCRIPTION:



















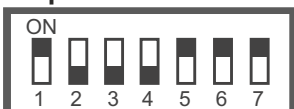

Continued from previous page.

Apartment code 61 	Apartment code 62 	Apartment code 63 	Apartment code 64 
Apartment code 65 	Apartment code 66 	Apartment code 67 	Apartment code 68 
Apartment code 69 	Apartment code 70 	Apartment code 71 	Apartment code 72 
Apartment code 73 	Apartment code 74 	Apartment code 75 	Apartment code 76 
Apartment code 77 	Apartment code 78 	Apartment code 79 	Apartment code 80 
Apartment code 81 	Apartment code 82 	Apartment code 83 	Apartment code 84 
Apartment code 85 	Apartment code 86 	Apartment code 87 	Apartment code 88 
Apartment code 89 	Apartment code 90 	Apartment code 91 	Apartment code 92 
Apartment code 93 	Apartment code 94 	Apartment code 95 	Apartment code 96 
Apartment code 97 	Apartment code 98 	Apartment code 99 	Apartment code 100 
Apartment code 101 	Apartment code 102 	Apartment code 103 	Apartment code 104 

Continued overleaf

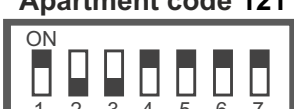

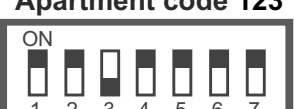
TERMINAL DESCRIPTION:

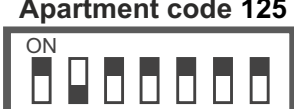
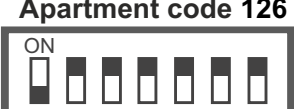
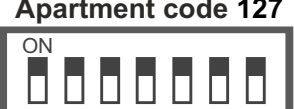
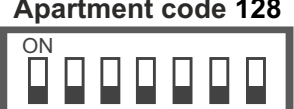
Continued from previous page.

<p>Apartment code 105</p> 	<p>Apartment code 106</p> 	<p>Apartment code 107</p> 	<p>Apartment code 108</p> 
<p>Apartment code 109</p> 	<p>Apartment code 110</p> 	<p>Apartment code 111</p> 	<p>Apartment code 112</p> 
<p>Apartment code 113</p> 	<p>Apartment code 114</p> 	<p>Apartment code 115</p> 	<p>Apartment code 116</p> 
<p>Apartment code 117</p> 	<p>Apartment code 118</p> 	<p>Apartment code 119</p> 	<p>Apartment code 120</p> 
<p>Apartment code 121</p> 	<p>Apartment code 122</p> 	<p>Apartment code 123</p> 	<p>Apartment code 124</p> 
<p>Apartment code 125</p> 	<p>Apartment code 126</p> 	<p>Apartment code 127</p> 	<p>Apartment code 128</p> 

TERMINAL DESCRIPTION:**Autoswitch-on function:**

With the ART 1/G2+ terminal in standby mode, you can establish an audio communication with the master door panel. It is only operative if there is no communication in progress.



With the terminal in standby mode, press the button  for 3 seconds, a confirmation tone will sound and the led of the button  on the terminal will turn on, indicating that audio communication has been established with the master door panel.

The communication will last for one and a half minutes or until the button  is pressed again.



Intercom function:

Intercom functionality between two points in the same apartment comes as standard with the ART 1/G2+ terminal.

The terminal must be in standby to make intercom calls.

To make an intercom call, press button  two short times, the led on button  of the terminal that makes the intercom call and the terminals that receive the call will blink and some tones in the apartment terminals will confirm that the call is being made.

The call needs to be answered within 40 seconds.



To establish communication, press button  of any called terminal of the apartment (if there is more than one slave terminal), the led of the button  of the terminals in communication will turn on and the rest of the terminals of the apartment the led of the button  will turn off.

Communication will last for one and a half minutes or until button  is pressed again.



"Automatic door opening" mode:

The ART 1/G2+ terminal allows you to activate/deactivate the "automatic door opening" mode.

Activate "automatic door opening" mode:

Note: With V06 or later, with the terminal in stand-by mode, press the button  for 10 seconds, a confirmation tone will sound and the led of the button  on the terminal will turn on (red), indicating that the "automatic door opening" mode has been activated (3 seconds after receiving a call from the door panel).

Deactivate "automatic door opening" mode

Note: With V06 or later, with the terminal in stand-by mode, press the button  for 10 seconds, a confirmation tone will sound and the led of the button  on the terminal will turn off, indicating that the "automatic door opening" mode has been deactivated.

Light activation function:

The ART 1/G2+ terminal must be in standby for light activation (requires SAR-G2+ and SAR-12/24 module).

To activate the light (e.g. "staircase light"), press the button  for 3 seconds until you hear 2 confirmation tones indicating that the light has been activated.

Important: For connection and configuration, see TSAR-G2+ and TSAR-12/24 manual.



Setting audio volume in the terminal:

The terminal allows you to change the volume of the audio in the speaker of the communicating terminal (between 4 levels from minimum to maximum in carousel mode) through the function button .



The terminal must be in communication, a short press on the button , allows to change the audio volume on the terminal speaker, each short press reproduces the selected volume (between 4 levels from minimum to maximum and in carousel mode), stop pressing once the desired volume level is selected on the terminal. When communication has finished, the selected volume will be saved in the terminal.

Setting call tone volume & 'Do not disturb' mode function:

The terminal must be in standby mode to adjust the volume of the call tone or to activate/deactivate the "do not disturb" mode.

A short press on the button  allows you to change the volume of the call tone, each short press reproduces the selected volume (minimum/ medium/ maximum and no volume in "do not disturb" mode), stop pressing once the "do not disturb" mode has been selected (the LED on the button  turn on in red) or the volume of the desired call tone.

If the "do not disturb" mode has been selected, the LED on the button  will turn on (red), indicating that the "do not disturb" mode is active. The terminal will not sound the ring tone when a call is received (see note "HZ" on page 4).

To deactivate the "do not disturb" mode, press the button , each short press reproduces the selected volume (minimum/ medium/ maximum and no volume "do not disturb" mode), stop pressing once the volume (minimum/ medium or maximum) of the desired call tone has been selected; the LED on the button  will turn off indicating that the "do not disturb" mode is deactivated.

Continued overleaf

TERMINAL DESCRIPTION:

Continued from previous page.

Configuration & selection of the call tone:

The terminal must be in standby mode for the configuration and selection of the desired call tone.

To modify the call tones, press the button  for 3 seconds until you hear 3 confirmation tones that indicate that the terminal is in configuration mode. Once in configuration mode, press the corresponding button to change the call tone (between 6 different ring tones and in carousel mode):

- To change the "apartment front door button" (HZ) call tone, press the button **AUX**.

Each short press on the button **AUX** reproduces a different call tone, stop pressing once you have selected the desired "apartment front door button" call tone on the terminal.

- To change the "intercom" call tone, press the button .

Each short press on the button  reproduces a different call tone, stop pressing once you have selected the desired "intercom" call tone on the terminal.

- To change the "guard monitor" call tone, press the button .

Each short press on the button  reproduces a different call tone, stop pressing once you have selected the desired "guard monitor" call tone on the terminal.

- To change the door panel call tone, press the button .

Each short press on the button  reproduces a different call tone, stop pressing once you have selected the desired door panel call tone on the terminal.

To exit and save the selected call tone in the terminal, press the button  for 3 seconds until you hear 2 confirmation tones indicating that the terminal has saved and left the configuration mode.

Make a call to check that the terminal has been configured with the desired call tones.

Tones, volume call tones & doctor mode default value:

The ART 1/G2+ terminal allows you to restore the tones, volume of the call tones and doctor mode to "default value".

With the terminal in standby mode, 5 short presses on the button **AUX**, 3 confirmation tones and the led of the button  of the terminal will blink 5 times, indicating that the tones, volume of the call tones and doctor mode in the terminal have been restored to their default value.

Cancel the 'call forwarding' process or 'communication' with door panel from G2Call+ App:

-If a call is made from the door panel to an apartment of a mixed video door entry system (ART 7W/G2+ monitors and ART 1/G2+ terminals in the same apartment) and the ART 7W/G2+ monitor has "call forwarding" configured and activated; from an ART 1/G2+ terminal in the same home, you can cancel the process of "call forwarding" to an smartphone by pressing the button  on the terminal to establish communication with door panel (information about this function, see the TART 7W G2+ manual).

-If smartphone is in communication with door panel from G2Call+ App, you can cancel the communication process to an smartphone by pressing the button  on the terminal for more than 3 seconds (information about this function, see the TART 7W G2+ manual).

INSTALLING THE TERMINAL IN A WALL MOUNTING CONNECTOR

Avoid dusty or smoky environments or locations near sources of heat.

Positioning the wall mounting connector:

The top of the wall mounting connector should be located at a height of 1.60m from the ground. The minimum distance between the wall mounting connector and the closest object must be 5 cm.

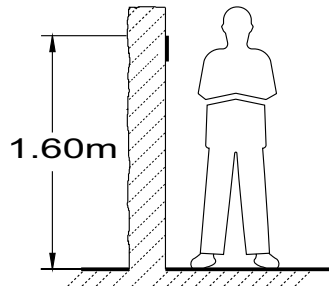

Fixing the terminal's wall mounting connector to the wall:

Fix the terminal's wall mounting connector to the wall by drilling two 6mm diameter holes and using the screws and plugs supplied with the terminal.

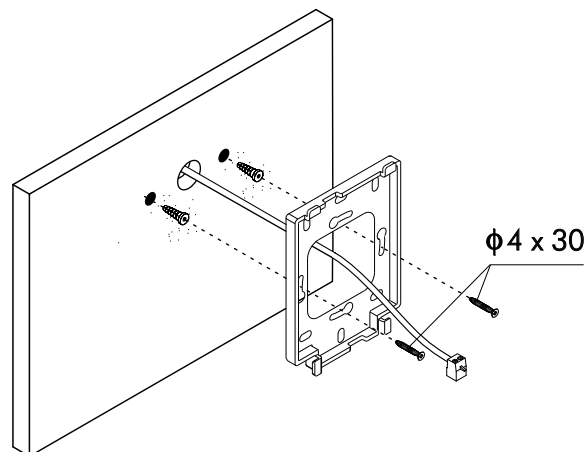

Positioning the terminal:

Connect the cables to the terminal (see p. 4), position the terminal in front of the wall mounting connector, ensuring that the holes in the base of the terminal line up with those on the connector ①, and then move the terminal downwards ② until the terminal is securely fixed to the connector ③.

Remember to remove the protective covering from the front of the terminal once installation has been completed.

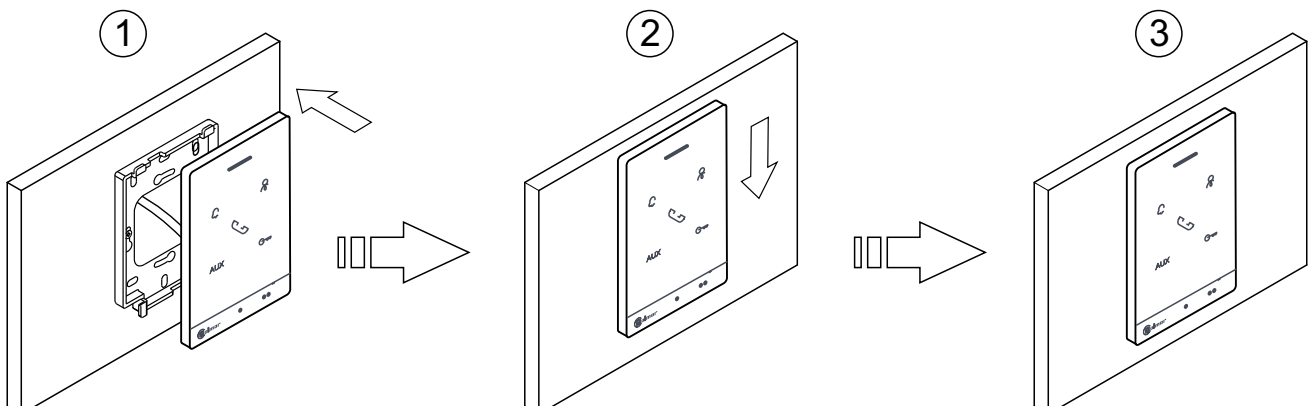

INSTALLATION OF THE TERMINAL IN AN EMBEDDING BOX

Avoid dusty or smoky environments or locations near sources of heat.

Positioning the embedding box:

Make a hole in the wall to position the top of the universal embedding box at a height of 1.60 m from the ground. The minimum distance between the sides of the embedding box and the closest object must be 5 cm.

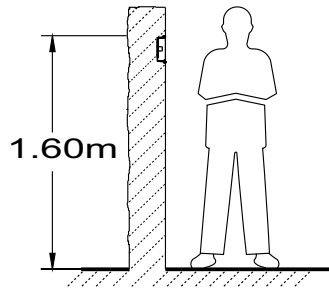

Positioning the embedding box and fitting the wall mounting connector:

Pass the cable through the hole made in the embedding box. Embed the box and ensure that it is level and flush. Fix the wall mounting connector of the terminal to the embedding box with the screws supplied.

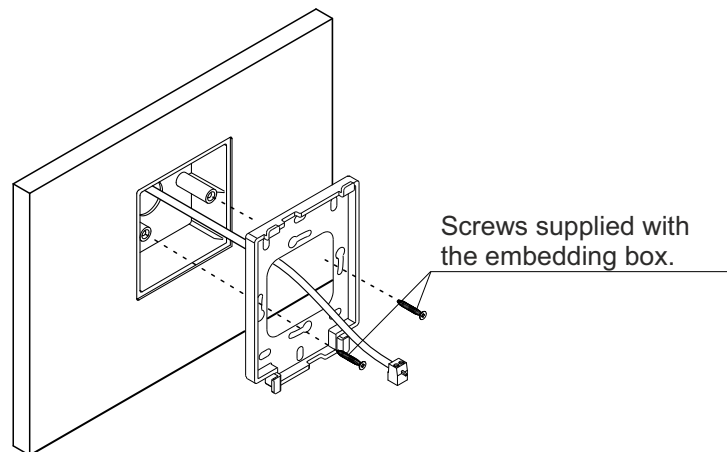

Positioning the terminal:

Connect the cables to the terminal (see p. 4), position the terminal in front of the wall mounting connector, ensuring that the holes in the base of the terminal line up with those on the connector ①, and then move the terminal downwards ② until the terminal is securely fixed to the connector ③.

Remember to remove the protective covering from the front of the terminal once installation has been completed.

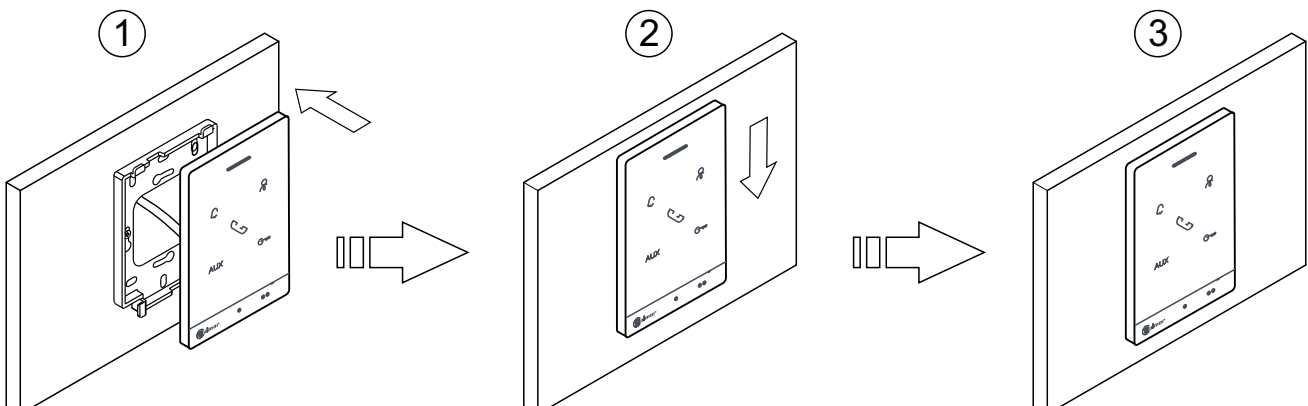

WIRING DIAGRAMS

Audio door entry system with 128 apartments / ART 1-G2+ terminals and Golmar d.c lock release.

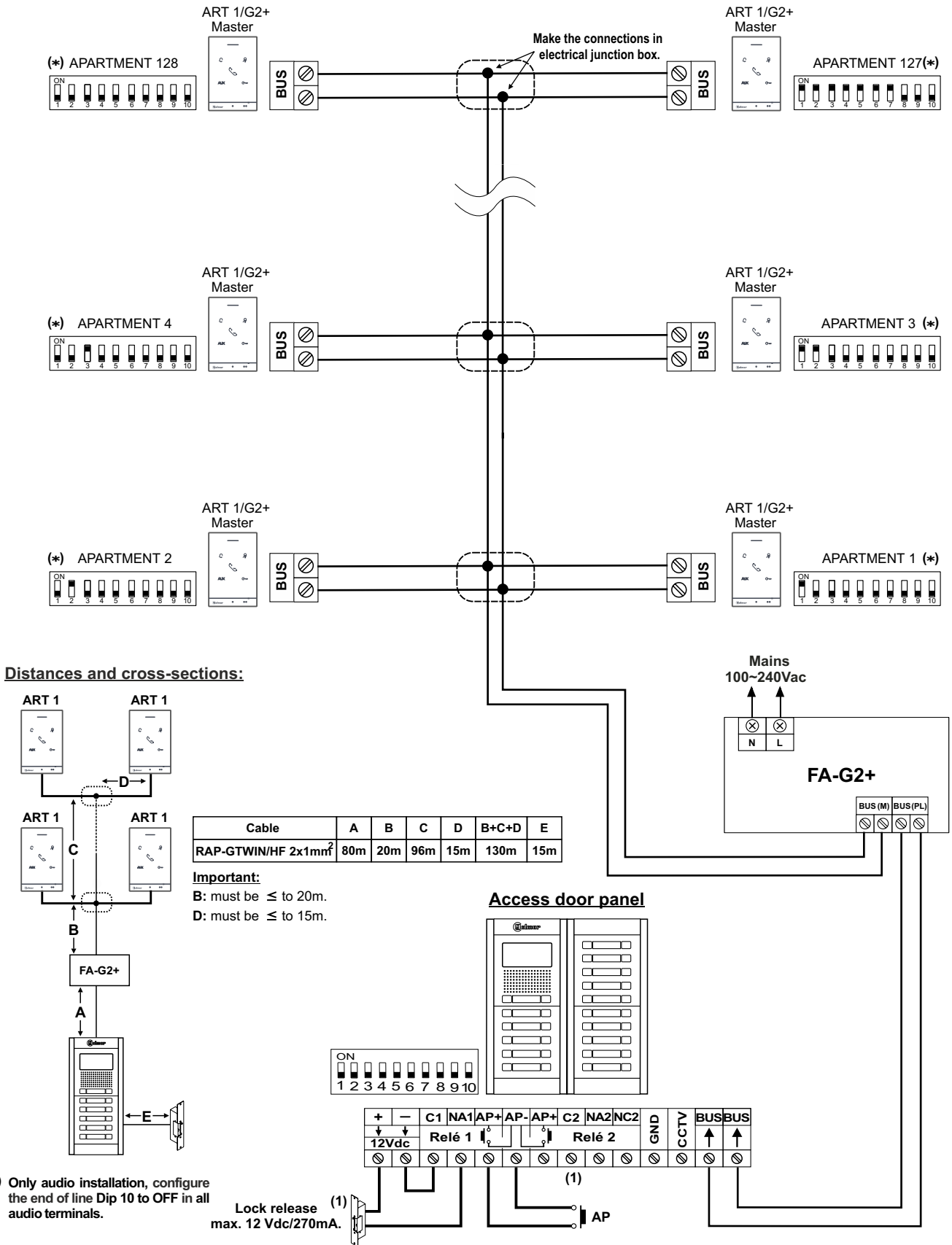

(1) For more information about the door panel, installation, configuration, connection of an AC lock release, 2nd lock release, mixed installation with monitors and ART 1/G2+ terminals and other wiring diagrams, (see the corresponding door panel manual).

CLEANING THE TERMINAL

- Do not use solvents, detergents or cleaning products that contain acids, vinegar or abrasive components.
- Use a soft damp lint-free cloth with water.
- Always wipe the terminal in the same direction, from top to bottom.
- After cleaning the terminal, remove any moisture with a soft dry lint-free cloth.

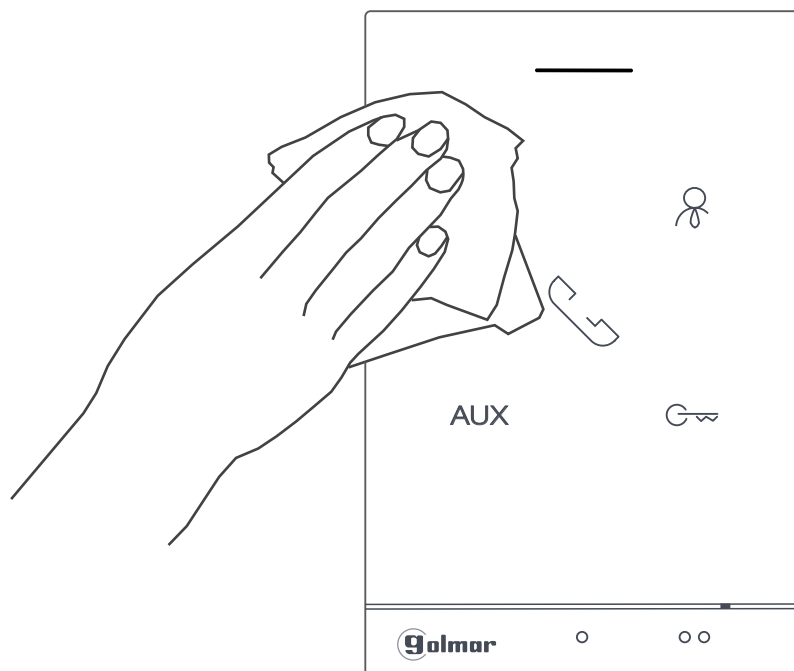

COMPLIANCE:

Este producto es conforme con las disposiciones de las Directivas Europeas aplicables respecto a la Compatibilidad Electromagnética **2014/30/CEE**.

*This product meets the essentials requirements of applicable European Directives regarding Electromagnetic Compatibility **2014/30/ECC**.*



NOTA: El funcionamiento de este equipo está sujeto a las siguientes condiciones:

(1) Este dispositivo no puede provocar interferencias dañinas, y (2) debe aceptar cualquier interferencia recibida, incluyendo las que pueden provocar un funcionamiento no deseado.

NOTE: Operation is subject to the following conditions:

(1) This device may not cause harmful interference, and (2) this device must accept any received interference, including the ones that may cause undesired operation.



golmar@golmar.es

www.golmar.es

GOLMAR S.A.
C/ Silici, 13
08940- Cornellá de Llobregat
SPAIN



Golmar se reserva el derecho a cualquier modificación sin previo aviso.

Golmar se réserve le droit de toute modification sans préavis.

Golmar reserves the right to make any modifications without prior notice.